

USER MANUAL

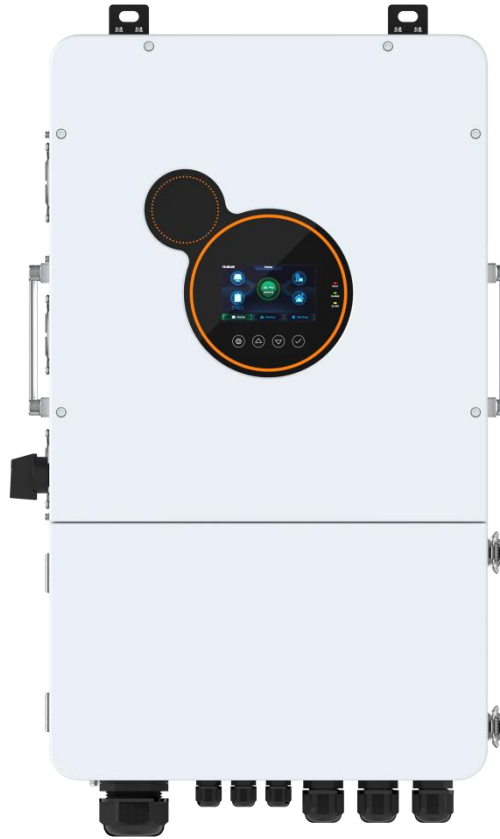

Solar Hybrid Inverter

SEI-8K-UP

SEI-10K-UP

SEI-12K-UP

Content

1. Safety	4
1.1、 How to use this manual	4
1.2、 Symbols in this manual	4
1.3、 Safety instruction	4
2. Production Instructions	5
2.1、 Instructions	5
2.3、 System connection diagram	6
2.4、 Production Overview	7
2.5、 Dimension drawing	8
3. Installation	9
3.1、 Select the mount location	9
3.2、 Mount the inverter	10
3.3、 Remove the terminal cover & anti insect net	10
4. Connection	11
4.1 Split-phase mode	11
4.2、 Cable & circuit breaker requirement	11
4.3 GRID & LOAD & GEN connection	14
4.4 Battery Connection	15
4.5 PV connection	15
4.6 Dry contact connection	17
4.7 Grounding connection	17
4.8 Final assembly	18
4.9 Start up the inverter	18
4.9.1 Introduction	18
4.9.2 Precautions for connecting the parallel connecting lines	18
5. Operation	26
5.1、 Operation and display panel	26
5.2、 Setting	30
5.3、 Time-slot charging/discharging function	43
5.4、 Battery parameter	44
6. Communication	46
6.1、 Overview	46
6.2、 USB-B port	46
6.4、 RS485 port	47
6.5、 CAN port	48
6.5、 External CT port	49
6.6、 Dry contact	50
7. Fault and Remedy	51
8. Protection and Maintenance	56

8.1 Protection features	56
8.2 Maintenance	58
9. Datasheet	59

1. Safety





1.1. How to use this manual

- This manual contains important information, guidelines, operation and maintenance for the following products

SEI Series : 8K-UP, 10K-UP, 12K-UP

- The manual must be followed during installation and maintenance

1.2. Symbols in this manual

Symbol	Description
 DANGER	DANGER indicates a hazardous situations which if not avoided will result in death or serious injury.
 WARNING	WARNING indicates a hazardous situations which if not avoided could result in death or serious injury.
 CAUTION	CAUTION indicates a hazardous situations which if not avoided could result in minor or moderate injury.
 NOTICE	NOTICE provide some tips on operation of products.

1.3. Safety instruction

DANGER

- This chapter contains important safety instructions. Read and keep this manual for future reference.
- Be sure to comply the local requirements and regulation to install this inverter.
- Beware of high voltage. Please turn off the switch of each power sources before and during the installation to avoid electric shock.
- For optimum operation of this inverter, please follow required specification to select appropriate cable size and necessary protective device.
- Do not connect or disconnect any connections when the inverter is working.
- Do not open the terminal cover when the inverter working.
- Make sure the inverter is well grounding.
- Never cause AC output and DC input short circuited.
- Do not disassembly this unit, for all repair and maintenance, please take it to the professional service center.
- Never charge a frozen battery.

2. Production Instructions

2.1. Instructions

SEI UPseries is a new type of solar energy storage inverter control inverter integrating solar energy storage & utility charging and energy storage, AC sine wave output. It adopts DSP control and features high response speed, reliability, and industrial standard through an advanced control algorithm.

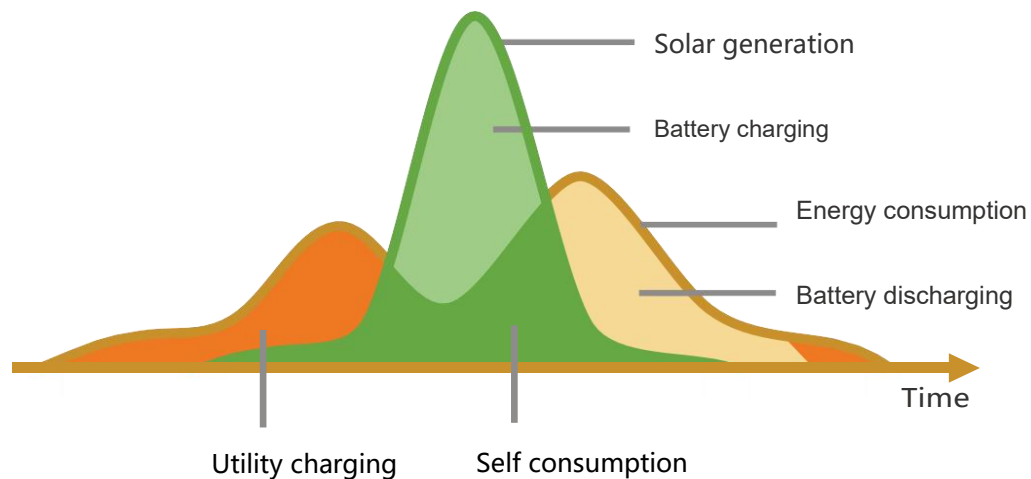

2.2. Features

- Supports lead acid battery and li-ion battery connections.
- With a dual activation function when the li-ion battery is dormant; either mains/photovoltaic power supply access can trigger the activation of the li-ion battery.
- Support single-phase pure sine wave output.
- Supports four different voltage levels of 100\105\110\120\127Vac per phase.
- Supports two solar inputs and simultaneous tracking of two solar maximum power charging/carrying capacity functions.
- Dual MPPT with 99.9% efficiency and maximum 25A current in a single circuit, perfectly adapted to high power modules.
- 2 charging modes are available: solar only, grid/solar hybrid charging.
- With the time-slot charging and discharging setting function, you can set the time period for cutting in/out of mains charging and switch the time period between battery discharging and mains bypass power supply mode.
- Energy saving mode function to reduce no-load energy losses.
- With two output modes of utility bypass and inverter output, with uninterrupted power supply function.
- LCD large screen dynamic flow diagram design, easy to understand the system data and operation status.
- 360° protection with complete short circuit protection, over current protection, over under voltage protection, overload protection, backfill protection, etc.
- Support CAN, USB, and RS485 communication.

2.3、 System connection diagram

The diagram below shows the system application scenario of this product. A complete system consists of the following components:

- **PV modules:** converts light energy into DC energy, which can be used to charge the battery via an inverter or directly inverted into AC power to supply the load.
- **Utility grid or generator:** connected to the AC input, it can supply the load and charge the battery at the same time. The system can also operate generally without the mains or generator when the battery and the PV module power the load.
- **Battery:** The role of the battery is to ensure the regular power supply of the system load when the solar energy is insufficient and there is no mains power.
- **Home load:** Various household and office loads can be connected, including refrigerators, lamps, televisions, fans, air conditioners, and other AC loads.
- **Inverter:** The energy conversion device of the whole system.

The actual application scenario determines the specific system wiring method

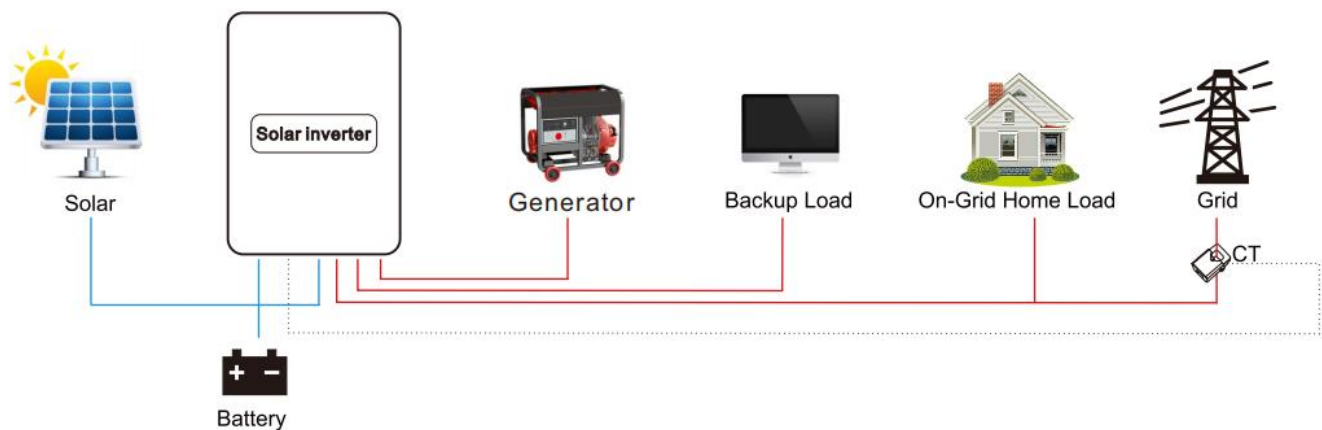

2.4、 Production Overview

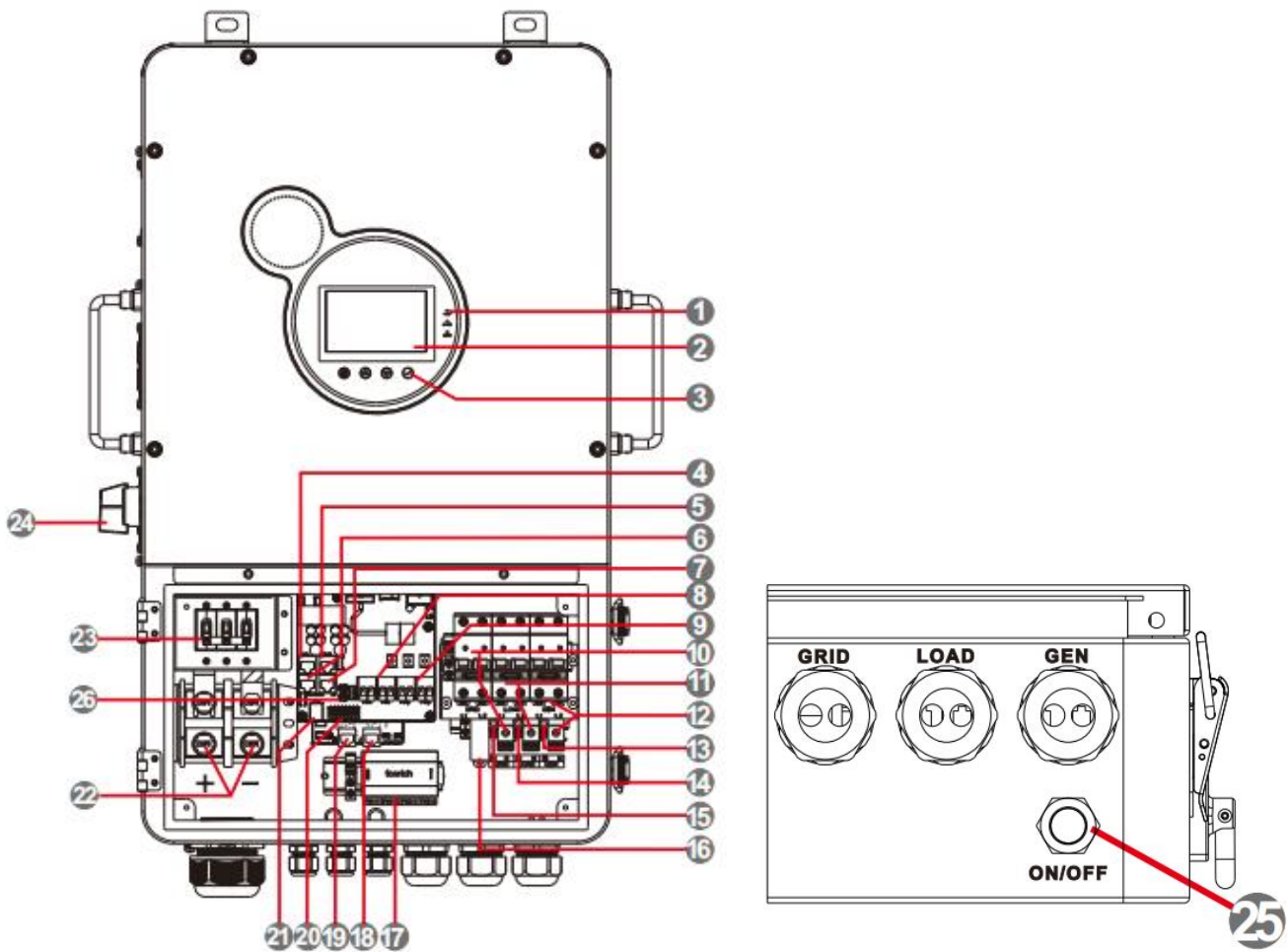

1	LED Indicators	14	Load ground terminal
2	LCD screen	15	Grid input ground terminal
3	mechanical key	16	Transmitter-PLC
4	WIFI port	17	AFCI
5	RS485 port	18	Parallel port A
6	External CT port	19	Parallel port B
7	CAN port	20	Dry contact
8	PV1 terminals	21	USB-B port
9	PV2 terminals	22	Battery Terminal
10	Utility terminals (L1+L2+N)+breaker	23	Battery Circuit Breaker
11	Load terminals (L1+L2+N) +Breaker	24	PV Circuit Breaker
12	Generator input terminal (L1+L2+N) +Breaker	25	ON/OFF switch
13	Generator Ground Terminal	26	USB-A port

2.5、 Dimension drawing

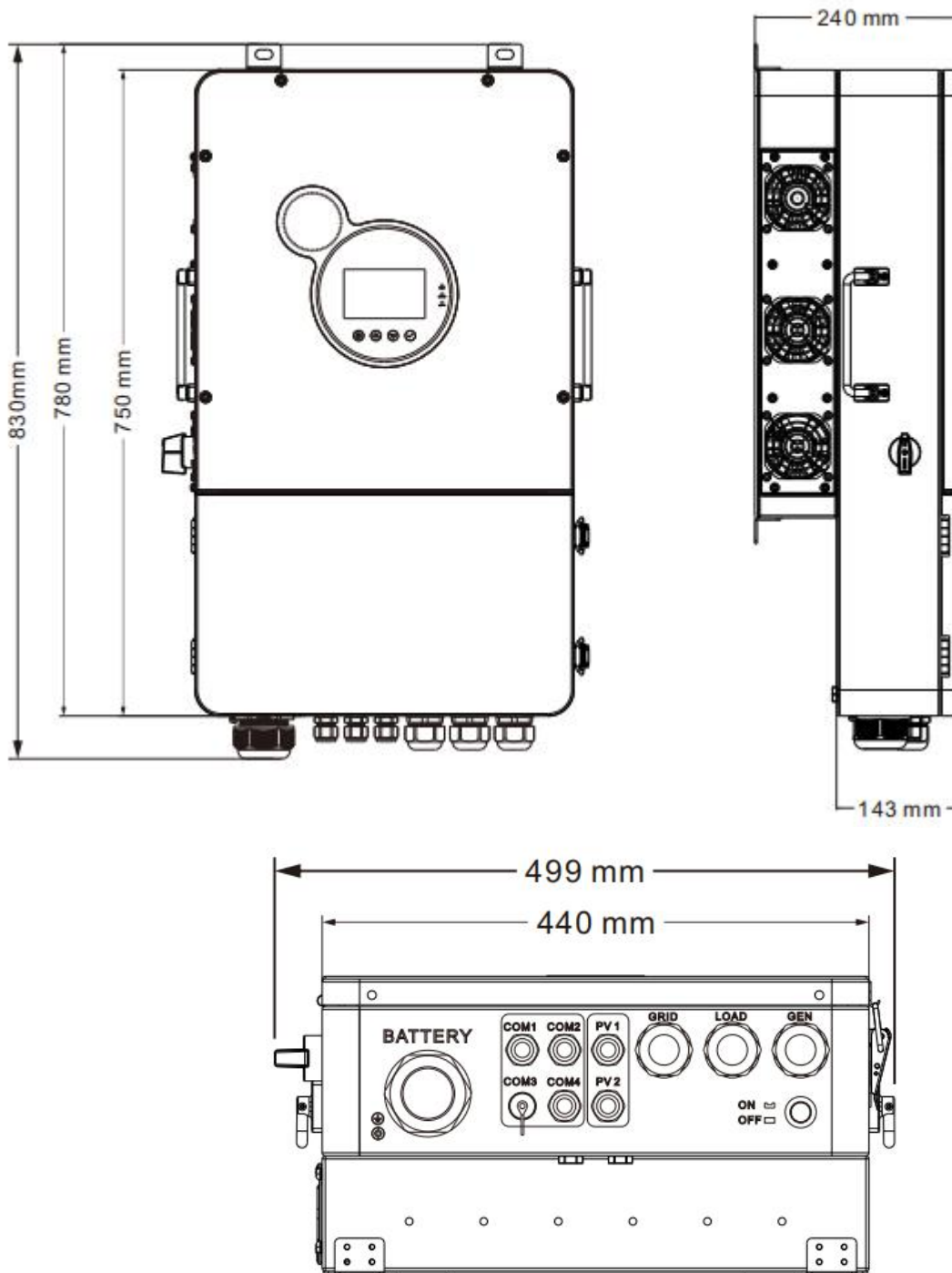

3. Installation

3.1、 Select the mount location

SEI UPseries can be used outdoors (protection class IP65). Please consider the followings before selecting the location:

- Choose the solid wall to install the inverter
- Mount the inverter at eye level
- Adequate heat dissipation space must be provided for the inverter
- Installation location is a cool and ventilated place, under the photovoltaic panels or under the eaves, do not direct sunlight exposure
- The ambient temperature should be between $-25\sim 60^{\circ}\text{C}$ ($-13\sim 140^{\circ}\text{F}$) to ensure optimal operation

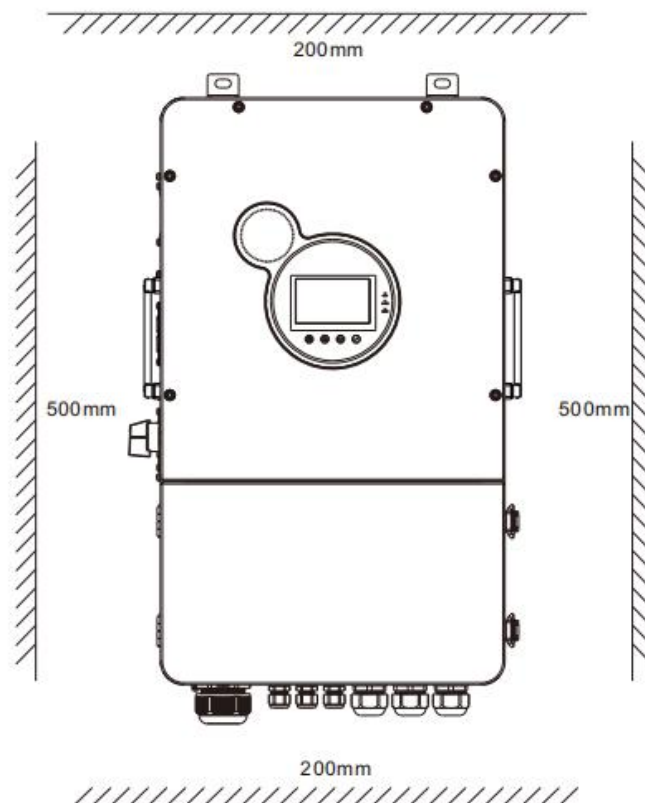

⚠ DANGER

- Do not install the inverter near flammable materials
- Do not install the inverter in potentially explosive areas
- Do not install the inverter and lead-acid batteries in enclosed spaces."

⚠ CAUTION

- Do not install the inverter in direct sunlight.

3.2、 Mount the inverter

Punch 4 mounting holes in the wall with an electric drill according to the specified size, and insert four M8*60 expansion screws above.

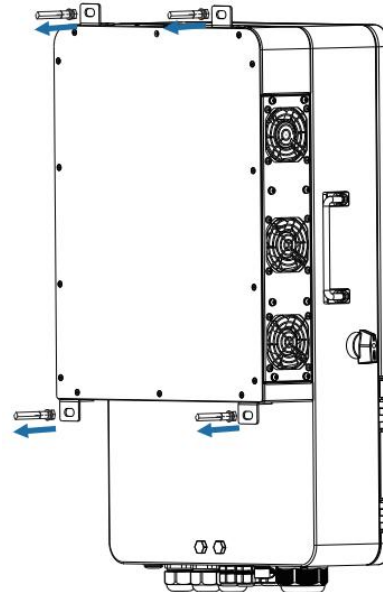
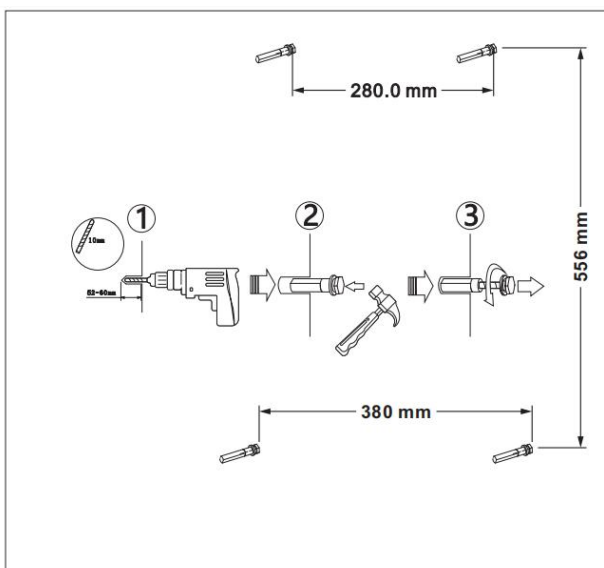

3.3、 Remove the terminal cover & anti insect net

Using a screwdriver, remove the fan shroud and open the cover.

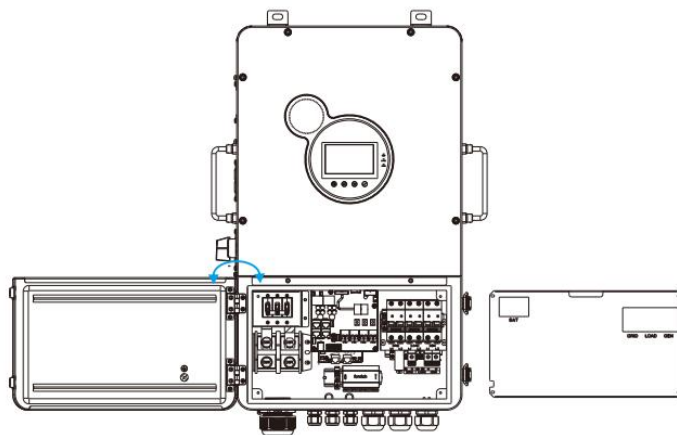

Removable fan cover
for cleaning

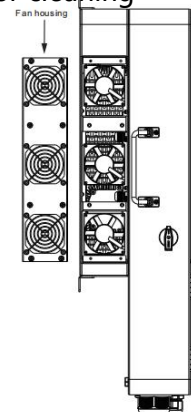

ⓘ NOTICE

- When using the device in areas with poor air quality, the fan cover is easily blocked by air particles, please disassemble and clean the fan regularly to avoid affecting the inverter's internal air flow rate, which may trigger the device over-temperature protection fault (19/20 faults) affecting the power supply and the service life of the inverter.

4. Connection

4.1 Split-phase mode

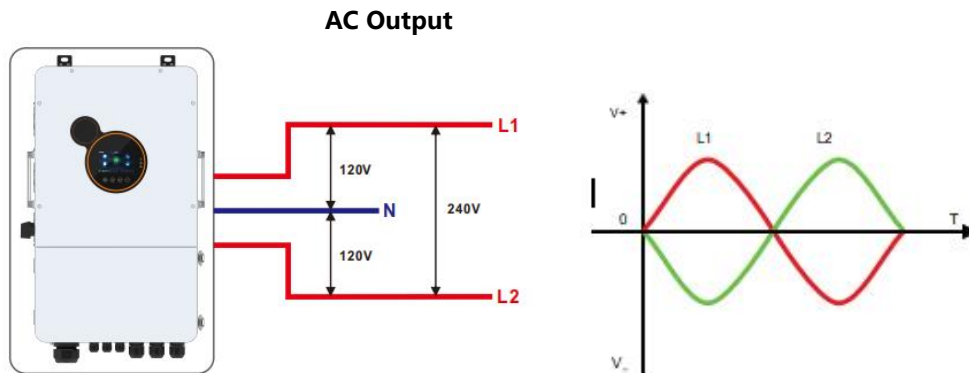

Items	Description
Applicable Model	SEI UP series
AC Output Phase Voltage (L-N)	100~120Vac, 120Vac (default)
AC Output Line Voltage (L1-L2)	200~240Vac, 240Vac (default)

4.2、 Cable & circuit breaker requirement



● PV INPUT

Model	No. of PV	Cable Diameter	Max. PV Input Current	Circuit Breaker Spec
SEI-8K-UP	PV1	6mm ² / 10 AWG	25A	2P-25A
	PV2	6mm ² / 10 AWG	25A	2P-25A
SEI-10K-UP	PV1	6mm ² / 10 AWG	25A	2P-25A
	PV2	6mm ² / 10 AWG	25A	2P-25A
SEI-12K-UP	PV1	6mm ² / 10 AWG	25A	2P-25A
	PV2	6mm ² / 10 AWG	25A	2P-25A



● BATTERY

Model	Cable Diameter	Max. Battery Current	Circuit Breaker Spec
SEI-8K-UP	34mm ² / 2 AWG	200A	2P-250A
SEI-10K-UP	42mm ² / 1 AWG	230A	2P-250A
SEI-12K-UP	54mm ² / 0 AWG	270A	2P-300A



● AC INPUT

Model	Schema	Cable Diameter	Circuit Breaker Spec
SEI-8K-UP		13mm ² /6AWG (L1/L2/N)	3P-63A
SEI-10K-UP		13mm ² /6AWG (L1/L2/N)	3P-63A
SEI-12K-UP		13mm ² /6AWG (L1/L2/N)	3P-63A

● GENERATOR INPUT

Model	Schema	Cable Diameter	Circuit Breaker Spec
SEI-8K-UP		13mm ² /6AWG (L1/L2/N)	3P-63A
SEI-10K-UP		13mm ² /6AWG (L1/L2/N)	3P-63A
SEI-12K-UP		13mm ² /6AWG (L1/L2/N)	3P-63A

● AC OUTPUT

Model	Schema	Cable Diameter	Circuit Breaker Spec
SEI-8K-UP		13mm ² /6AWG (L1/L2/N)	3P-63A
SEI-10K-UP		13mm ² /6AWG (L1/L2/N)	3P-63A
SEI-12K-UP		13mm ² /6AWG (L1/L2/N)	3P-63A

ⓘ NOTICE

• **PV Input, AC Input, AC Output, Generator Input**

1. Use a stripper to remove the 6~8mm insulation of the cable
2. Fixing a ferrule at the end of the cable. (ferrule needs to be prepared by the user)

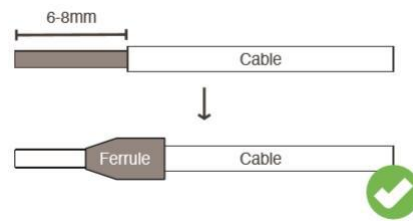

• **BATTERY**

1. Use a stripper to remove the 6~8mm insulation of the cable
2. Fixing cable lugs that supply with the box at the end of the cable.

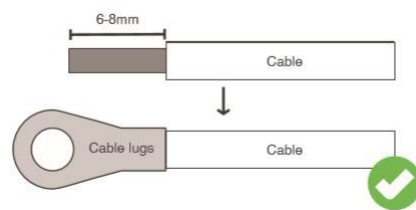

The wire diameter is for reference only. If the distance between the PV array and the inverter or between the inverter and the battery is long, using a thicker wire will reduce the voltage drop and improve the performance of the system.

4.3 GRID & LOAD & GEN connection

Connect the live, neutral and ground wires according to the cables' position and order shown in the diagram below.

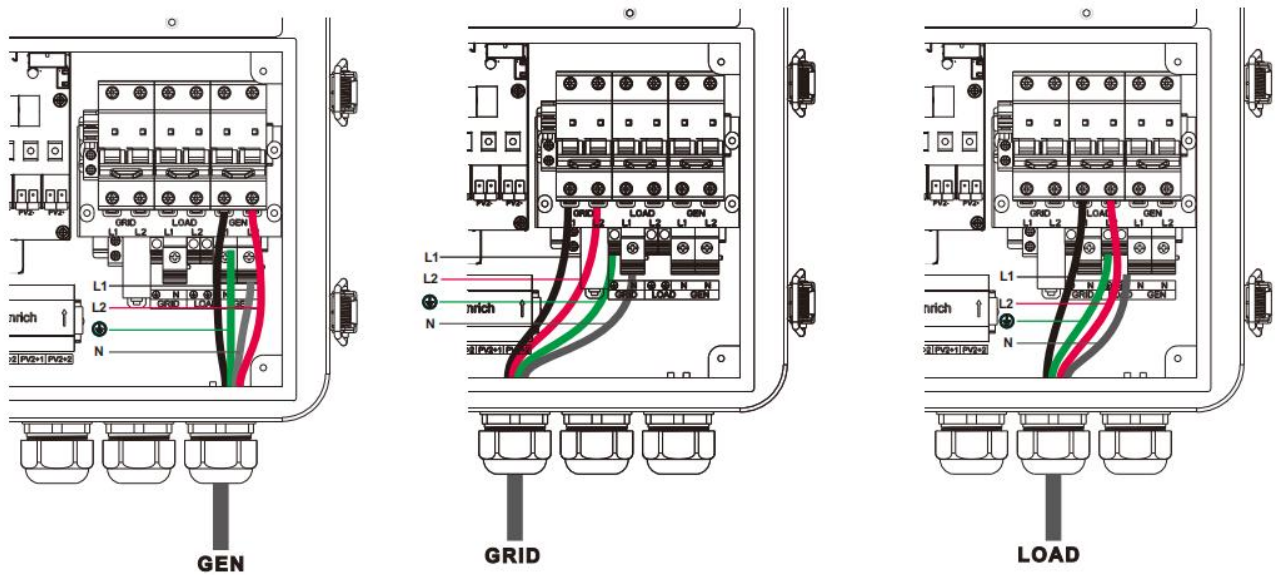

⚠ DANGER

- Before connecting AC inputs and outputs, the circuit breaker must be opened to avoid the risk of electric shock and must not be operated with electricity.
- Please check that the cable used is sufficient for the requirements, too thin, poor quality cables are a serious safety hazard.

4.4 Battery Connection

Connect the positive and negative cable of the battery according to the diagram below

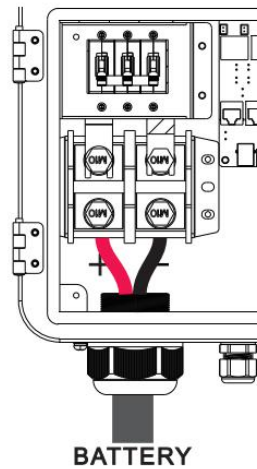

⚠ DANGER

- Before connecting battery, the circuit breaker must be opened to avoid the risk of electric shock and must not be operated with electricity.
- Make sure that the positive and negative terminals of the battery are connected correctly and not reversed, otherwise the inverter may be damaged.
- Please check that the cable used is sufficient for the requirements, too thin, poor quality.
- cables are a serious safety hazard.

4.5 PV connection

Connect the positive and negative wires of both PVs in the cable locations and sequence shown in the diagram below. The positive wire runs through the AFCI unit.

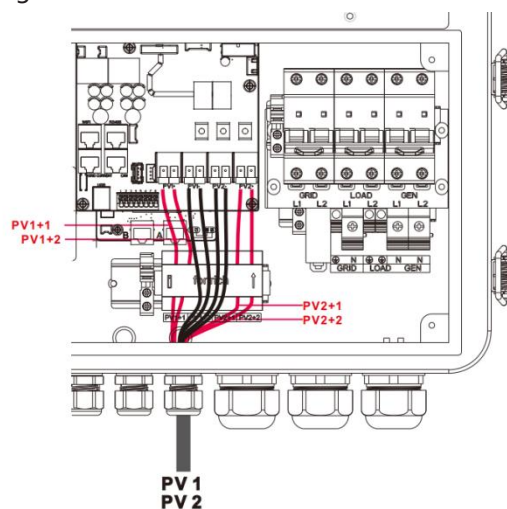

⚠ DANGER

- Before connecting the PV, the circuit breaker must be disconnected to avoid the risk of electric shock and must not be energized.
- Make sure that the open-circuit voltage of the PV modules connected in series does not exceed the maximum open-circuit voltage of the inverter (the value is 550V), otherwise the inverter may be damaged.

Transmitter-PLC Device

The APsmart Rapid Shutdown System Transmitter-PLC is part of a rapid shutdown solution when paired with APsmart RSD-D, a PV module rapid shutdown unit. While powered on, the Transmitter-PLC sends a signal to the RSD-D units to keep their PV modules connected and supplying energy.

RSD-D units automatically enter rapid shutdown mode when the Transmitter-PLC is switched off and resume energy production when power is restored to the Transmitter-PLC

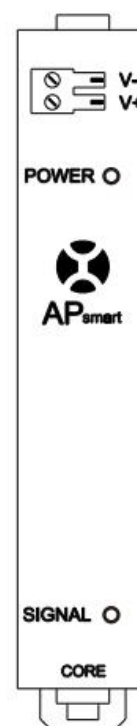

4.6 Dry contact connection

Use a small screwdriver to push back the direction indicated by the arrow, then insert the communication cable into the dry junction port. (Communication cable diameter 0.2~1.5mm²)

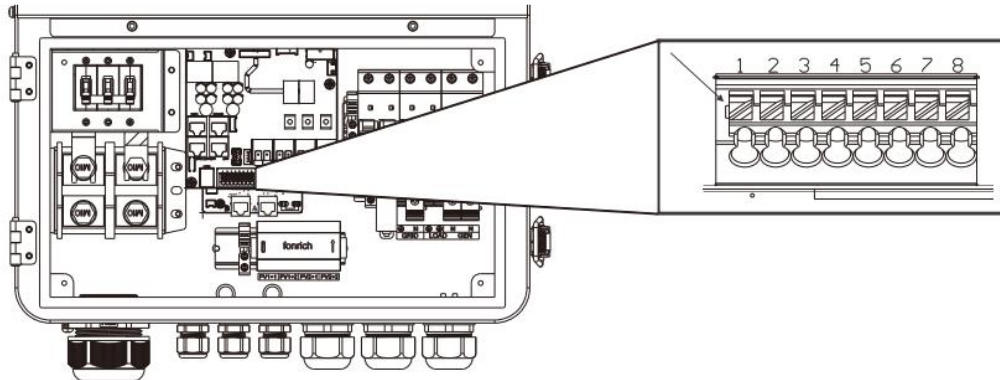

4.7 Grounding connection

Please make sure the grounding terminal connect to the Grounding Bar.

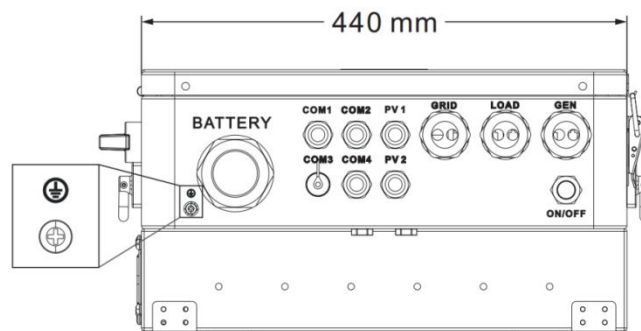

ⓘ NOTICE

- The grounding cable should have a diameter of not less than 4 mm² and be as close as possible to the grounding point.

4.8 Final assembly

After ensuring that the wiring is reliable and the wire sequence is correct, install the terminal protection cover in place.

- **Step 1** : Close the circuit breaker of the battery.
- **Step 2**: Press the rocker switch on the bottom of inverter, the screen and indicators light up to indicate that the inverter has been activated.
- **Step 3**: Sequential close of the circuit breakers for PV, AC input and AC output.
- **Step 4**: Start the loads one by one in order of power from small to large

4.9 Start up the inverter

4.9.1 Introduction

1. Up to six units connected in parallel.
2. When using the parallel operation function, the following connecting lines (package accessories) shall be firmly and reliably connected:

Parallel communication line*1

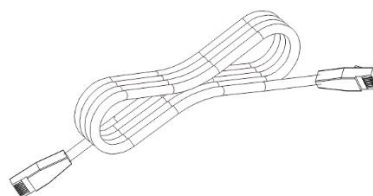

4.9.2 Precautions for connecting the parallel connecting lines

Warning 

1.PV connection:

When connected in parallel, the PV arrays of each machine must be independent and the PV arrays of PV1 and PV2 of each machine must also be independent.

2.Battery wiring:

Parallel connection in single or three-phase: ensure that all solar storage inverters are connected to the same battery, with BAT + connected to BAT + , BAT - connected to BAT -, and that the connection is correct with the same wiring length and line diameter before power on, so as to avoid the abnormal operation of parallel system output caused by wrong connection.

3.LOAD wiring:

When connecting the parallel machine, all the inverse control integrated machine must be connected to L and L, N and N line connected, PE and PE connected, and ensure that the power on and off before connecting correctly and the wiring length and wire diameter is the same, to avoid connecting incorrectly caused by the output of the parallel system does not work properly.

When connecting three-phase parallel machines, all inverse control integrated machines must be connected N to N wire and PE to PE. The L lines of all machines in the same phase need to be connected together, but the L lines of AC outputs of different phases cannot be connected together. Other precautions are the same as single-phase connection of parallel machines.

4.GRID wiring:

Parallel connection in single phase: ensure L-to-L, N-to-N and PE-to-PE connection for all solar storage inverters, and that the connection is correct with the same wiring length and line diameter before power on, so as to avoid the abnormal operation of parallel system output caused by wrong connection. Meanwhile, it is not allowed to have multiple different AC source inputs to avoid damage to the external equipment of the inverter. The consistency and uniqueness of AC source input shall be ensured.

Parallel connection in three-phase: ensure N-to-N and PE-to-PE connection for all solar storage inverters. The L lines of all inverters connected to the same phase need to be connected together. But L lines of different phases cannot be joined together. Other connection precautions are the same as parallel connection in single phase.

5.Wiring of parallel communication line:

Our parallel communication cable is a shielded 10Pin network connection cable, which can be used for single-phase or three-phase parallel connection. Each machine must be connected with one out and one in. This means that the machine "Parallel_A" is connected to the machine to be parallelized "Parallel_B", and that the machine "Parallel_A" is not allowed to connect to the "Parallel_B". "Parallel_B" or "Parallel_A" is connected to the machine to be parallelized "Parallel_A". At the same time, the parallel communication cable of each machine should be fastened with 10Pin network connection cable to avoid disconnection or poor contact of the parallel communication cable, which may cause abnormal operation or damage to the system output.

6.Before and after connecting the system, please check the following system wiring diagrams in detail to ensure that all wiring is correct and reliable before powering on.

7. After the system is wired, powered on and in normal operation, if a new inverter needs to be connected, make sure to disconnect the battery input, PV input, AC input and AC output, and that all solar storage inverters are powered off before reconnecting into the system

4.9.3 Split-phase parallel connection

Setting for each inverter: Select "Parallel" for parallel mode, select "Split Phase" for grid type, when "120V" is selected for output phase voltage, the output L1-L2 voltage is 240V, L1-N voltage is 120V, L2-N voltage is 120V.



The wiring diagram is shown below:

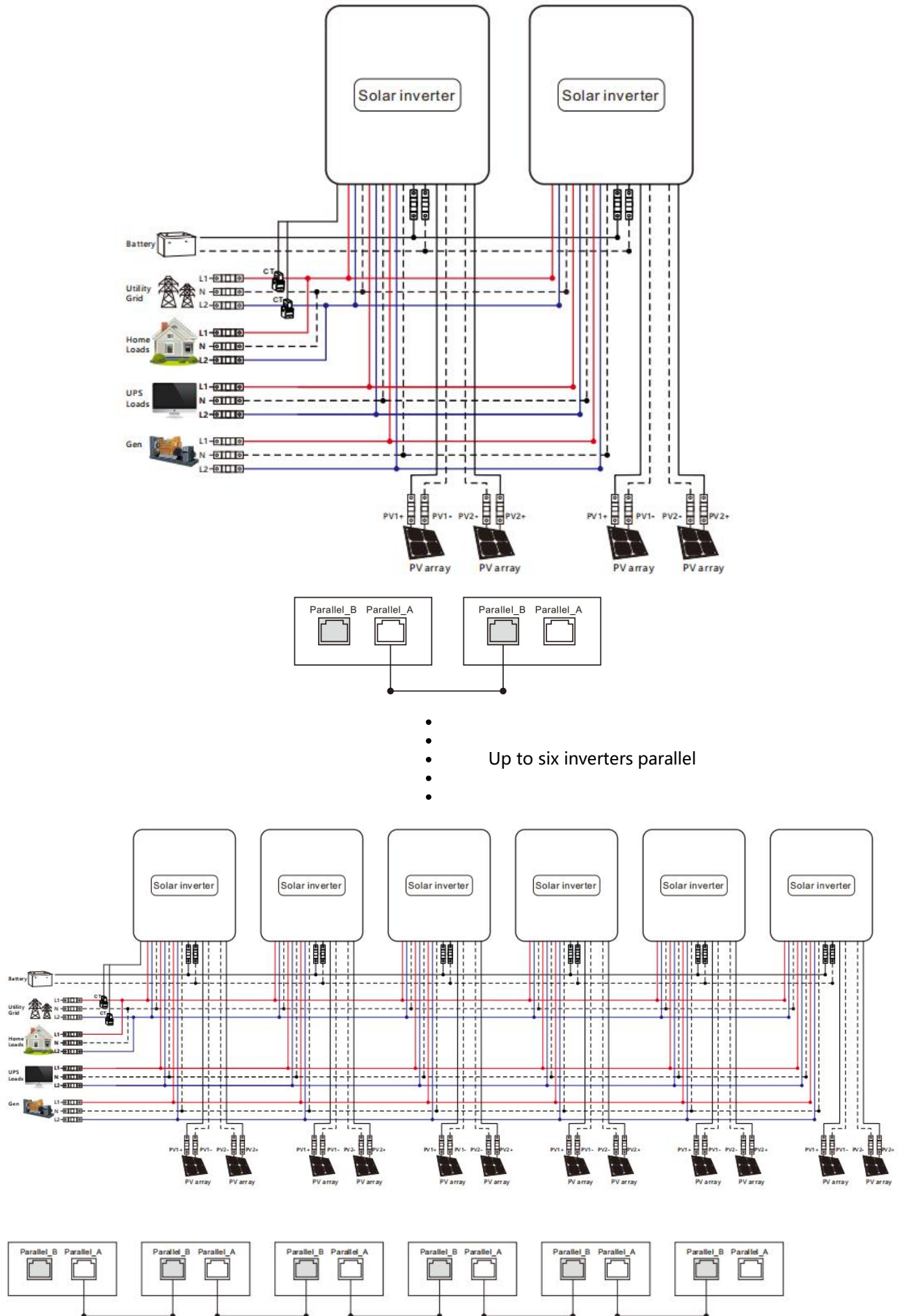

4.9.4 Three-phase parallel connection

(1) 2 inverters connected in parallel to form a three-phase output (three-phase unbalanced)

P1 machine setting: Parallel mode select "Three phase A", grid type select "Three Phase", when output phase voltage select "120V", the output L1-L2 voltage is 208V, L1-N voltage is 120V, L2-N voltage is 120V.

Work mode setup

Return OK

Work mode Peak shaving

Parallel mode

Three phase A

Output phase voltage

100V

105V

110V

120V

127V

Grid type

Single Phase

Three Phase

Split Phase

P2 machine setting: Parallel mode select "Three phase B", grid type select "Three Phase", when the output phase voltage select "120V", then the output L1-L2 voltage is 208V, L1-N voltage is 120V, L2-N voltage is 120V.

Work mode setup

Return OK

Work mode Peak shaving

Parallel mode

Three phase B

Output phase voltage

100V

105V

110V

120V

127V

Grid type

Single Phase

Three Phase

Split Phase

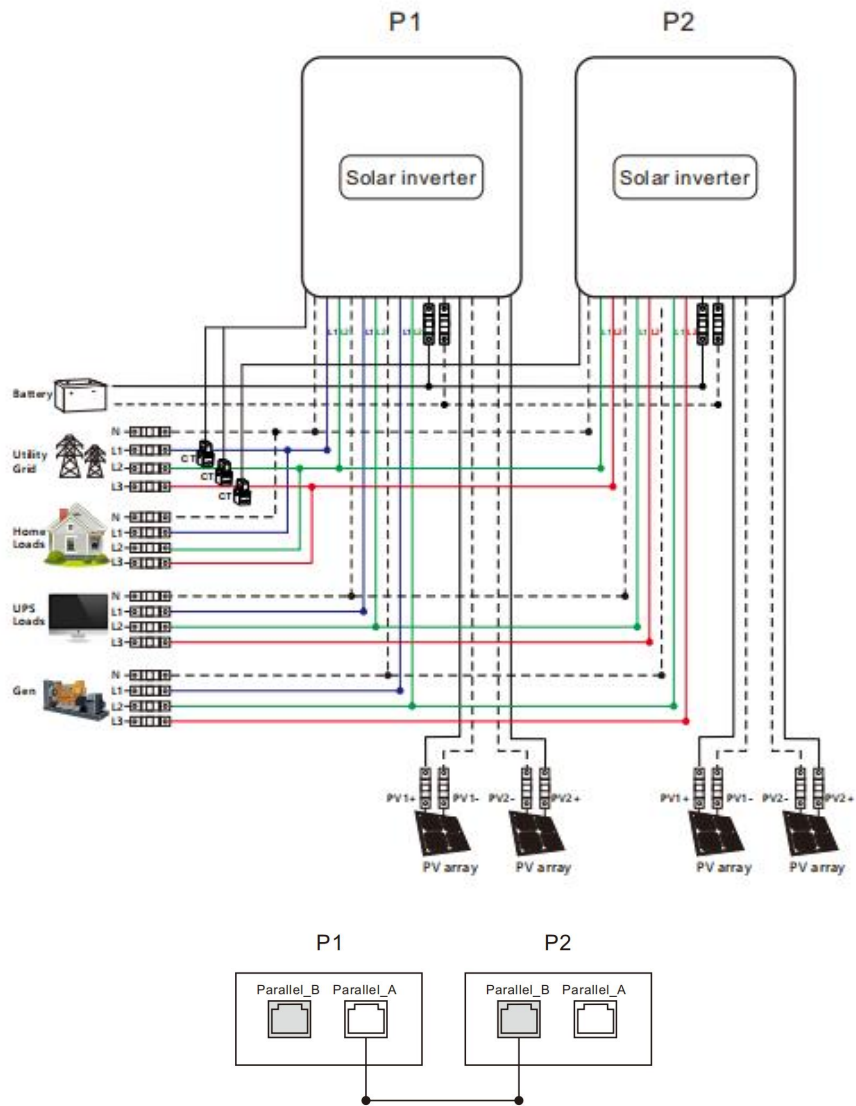

(2)3 or 6 inverters in parallel to form a three-phase output (three-phase balanced)

P1 machine setting: Parallel mode select "Three phase A", grid type select "Three Phase", when output phase voltage select "120V", the output L1-L2 voltage is 208V, L1-N voltage is 120V, L2-N voltage is 120V.

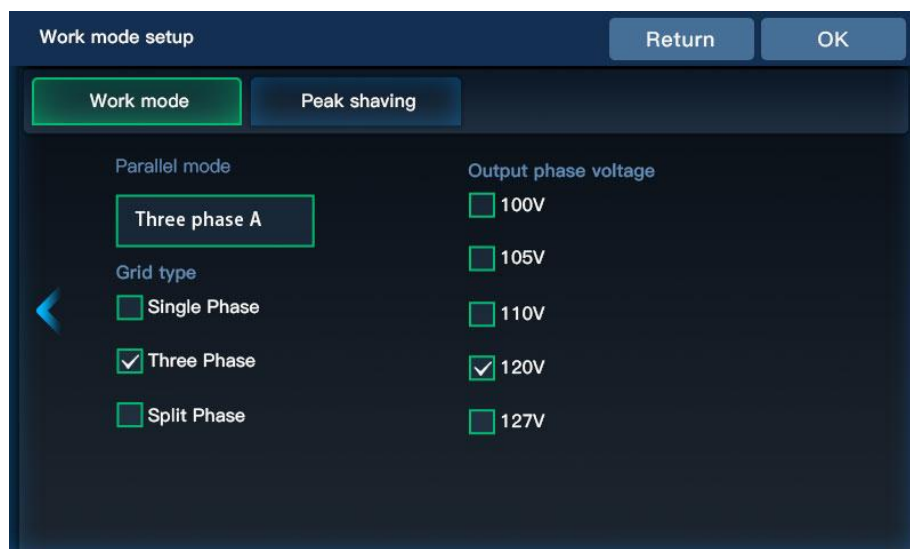

P2 machine setting: Parallel mode select "Three phase B", grid type select "Three Phase", when the output phase voltage select "120V", then the output L1-L2 voltage is 208V, L1-N voltage is 120V, L2-N voltage is 120V.



P3 machine setting: Parallel mode select "Three phase C", grid type select "Three Phase", when output phase voltage select "120V", then output L1-L2 voltage is 208V, L1-N voltage is 120V, L2-N voltage is 120V.



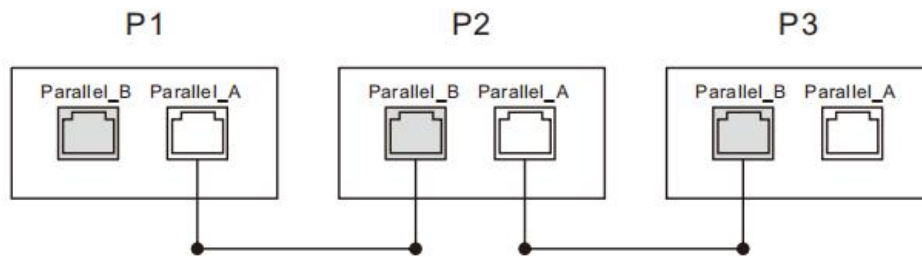
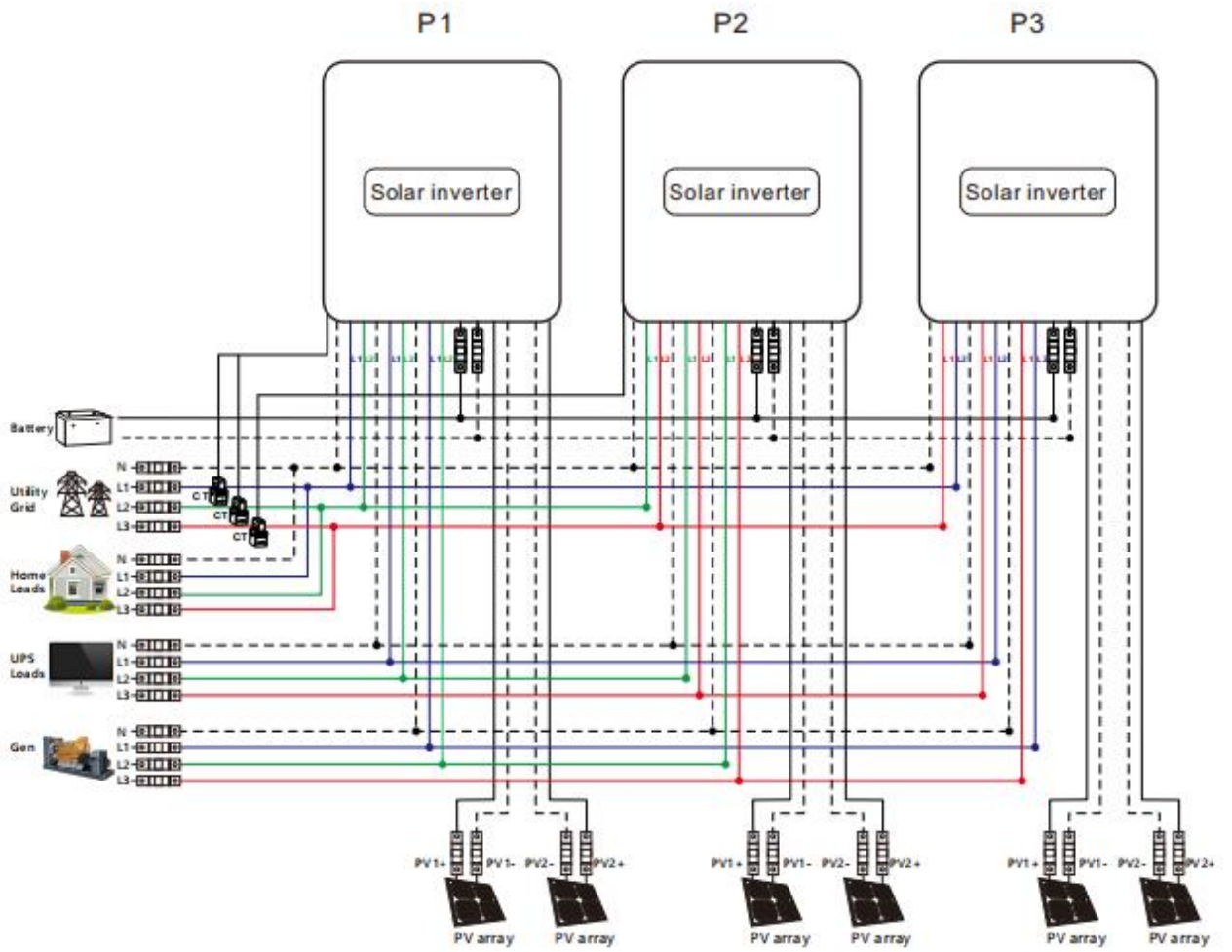

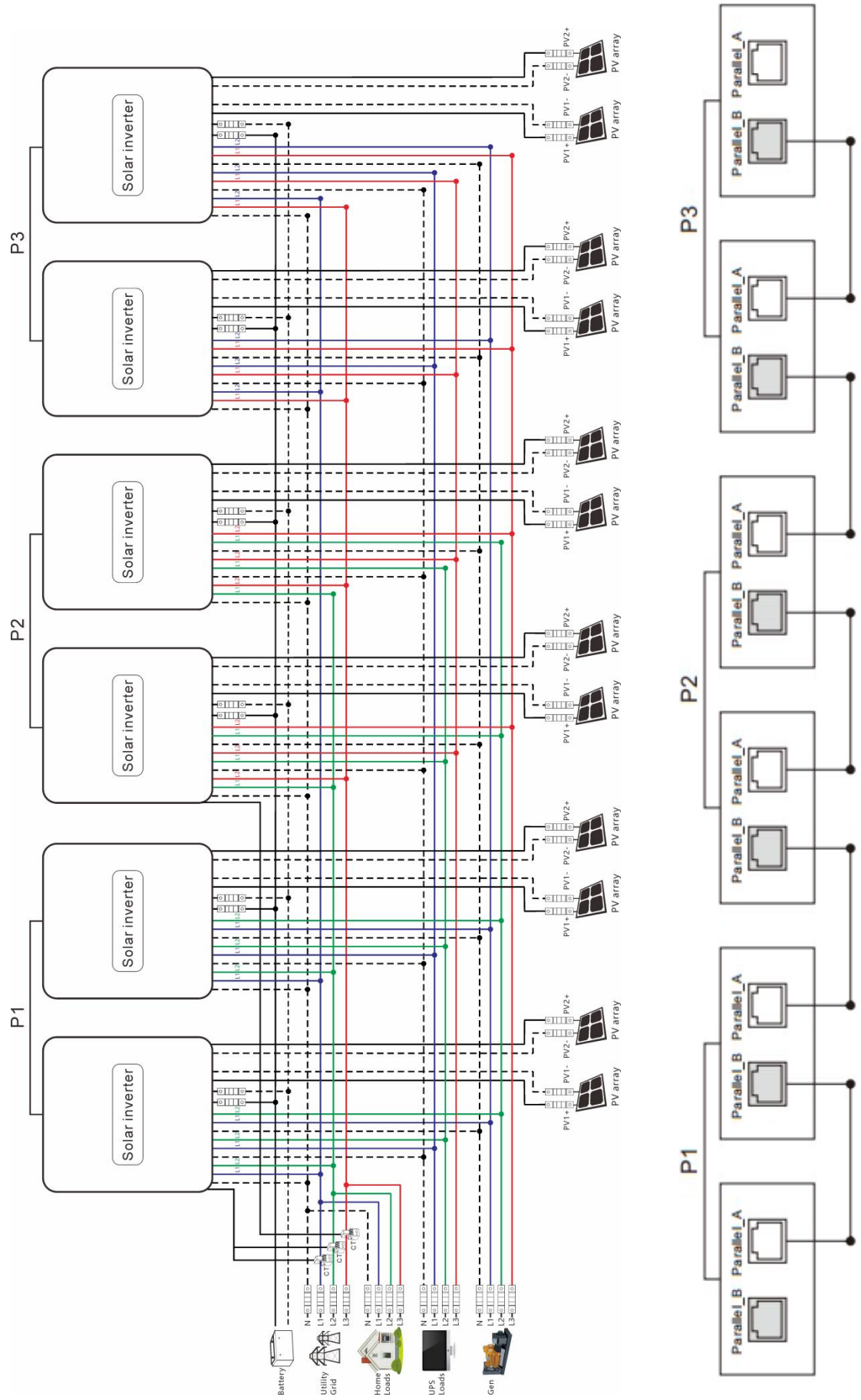



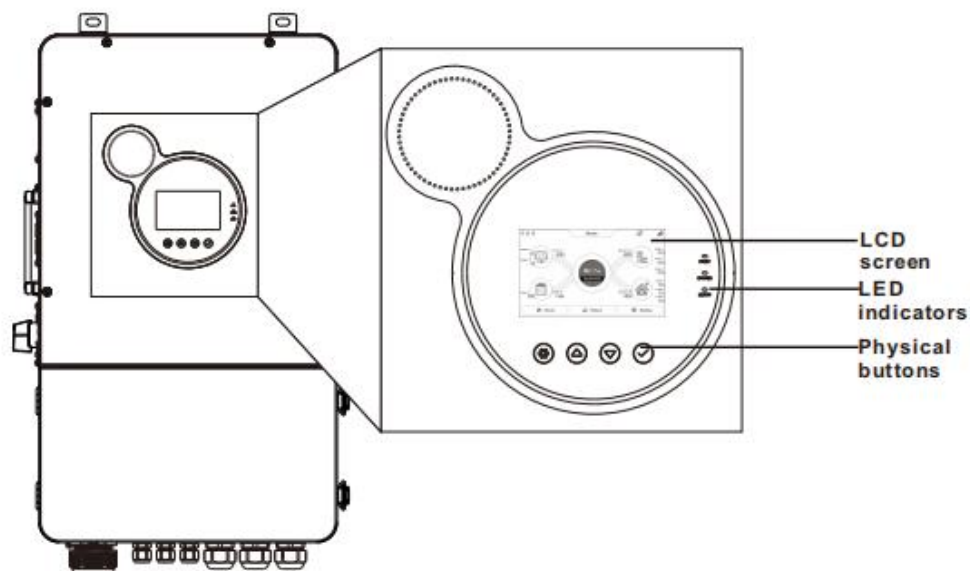

5. Operation

5.1、 Operation and display panel

The operation and display panel below includes 1 LCD screen, 3 indicators, 4 Mechanical keys



- Mechanical keys

Mechanical keys	Description
	To enter/exit the setting menu
	To next selection
	To last selection
	To confirm/enter the selection in setting menu

- LED indicators

Yellow light for inverter Green light for charging

Indicators	Color	Description
FAULT	Red	Flash: error occur
CHARGE	Green	Continued: charging complete
		Flash: charging
AC/INV	Yellow	Continued: utility grid by-pass output
		Flash: inverter output

● Display panel



Icon	Description	Icon	Description
	Solar panel		Load
	Battery		Grid
	Home page		Inverter is Working
	History data		Setting
0 :0 :0	Local time		The buzzer is slient
	Indicates that the machine is currently in energy-saving mode.		The enery direction
UPS	UPS load power	HOME	Home load power

● View real-time data

On the LCD home screen, click the inverter icon, battery icon, mains icon, load icon and photovoltaic icon to view the real-time data of the machine.

System data			
No.	Item	No.	Item
1	Machine state	11	SN code
2	MCU1 version	12	Minor version
3	LCD version	13	Rated power
4	MCU2 version	14	RS485 Address
5	Customer ID	15	External Temperature
6	Inverter Temperature	16	PV Temperature
7	Transformer temperature	17	L1 Voltage
8	L1 Current	18	L2 Voltage
9	L2 Current	19	Positive busbar voltage
10	Negative busbar voltage	20	Total busbar voltage
Battery data			
1	SOH	6	Discharge current
2	SOC (Percentage of remaining battery capacity)	7	BMS protocol
3	Battery voltage	8	Battery type
4	Charge current	9	Battery Charge Status
5	Battery power (Battery charging and discharging power)		
Grid data			
1	L1 Voltage V	7	L2 Voltage
2	L1 Current A	8	L2 Current
3	L1 active power	9	L2 active power
4	L1 apparent power	10	L2 apparent power
5	Frequency	11	Grid charging current
Load data			
1	L1 Voltage	8	L2 Voltage
2	L1 Current	9	L2 Current
3	L1 UPS load active power	10	L2 UPS load active power
4	L1 UPS load apparent power	11	L2 UPS load apparent power
5	Frequency	12	load rate

6	L1 Home load power	13	L2 Home load power
PV data			
1	PV1 voltage V	5	PV2 voltage V
2	PV1 current A	6	PV2 current
3	PV1 power W	7	PV2 power
4	PV total power		

- Click on the history button in the menu bar below to access the historical data and view various types of historical data.

Tody data			
1	Battery charging energy	4	Load consumption energy
2	Battery discharging energy	5	Grid charging energy
3	Solar generated energy	6	Load consumption energy from grid
Historiy			
1	PV generation last seven days history	4	Mains charge energyfor last 7 days
2	Battery charging enery for last 7 days	5	Load consumption energyfor last 7 days
3	Battery discharge for last 7 days	6	Load consumption from the grid for last 7 days
Energy Statistics			
1	Total Battery Charging Energy	4	Total Battery Discharging Energy
2	Total solar generated energy	5	Total load consumption energy
3	Total grid charging energy	6	Total load consumption energy from grid
Historical faults			

5.2、 Setting

Operating instructions: Click on the settings in the menu bar at the bottom of the screen to enter the setup interface, including the basic settings, operating mode settings, battery settings, grid settings, advanced settings of the five major setup items

5.2.1 Basic Setup

5.2.1.1 Display Setup

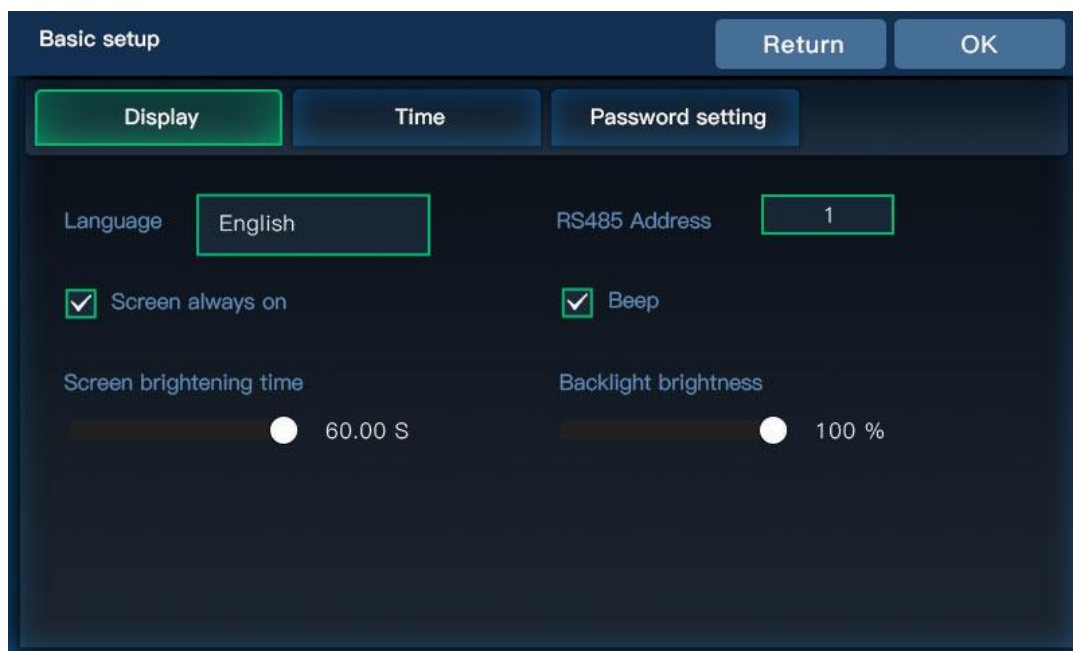

Parameter Meaning	Description
Language	Currently only English
RS485 Address	Display and current inverter RS485 address, range 1-255
Screen always on	Selectable whether the screen is always on or not
Beep	You can choice whether enable the Beep alarm
Screen brightening time	Setting range 0-60S
Backlight brightness	0-100%

5.2.1.2. Time Setup



5.2.1.3. Password Setting (Password is required to access the Grid Settings and Advanced Settings)

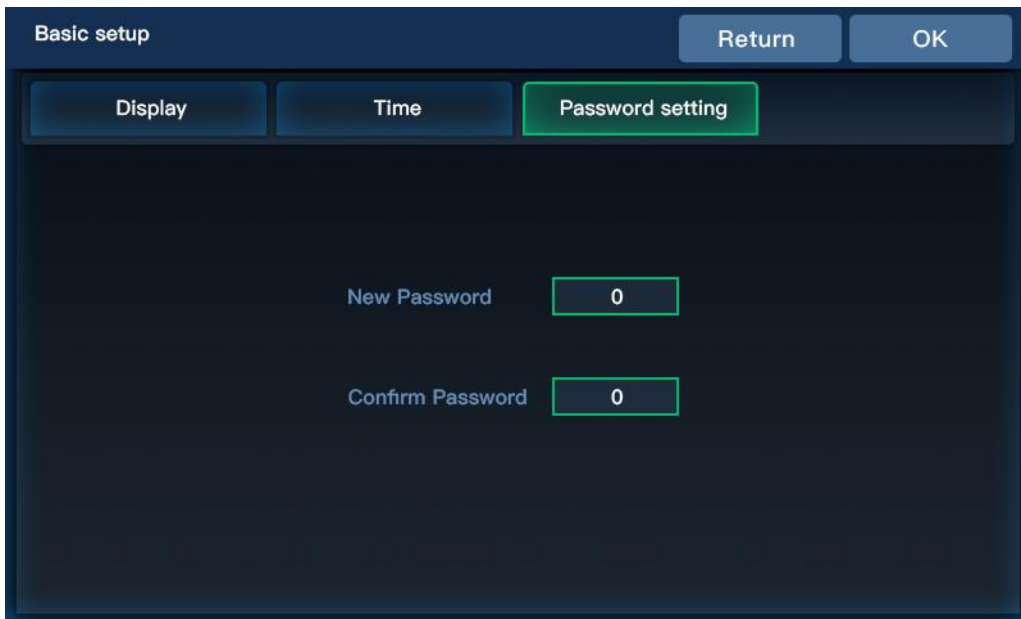

Default password is "00000".

Password setting value range: 0-65535

5.2.2 Work Mode Setup

5.2.2.1. Work Mode



Home Load: connected to the GRID port of the machine, requires external CT for monitoring.

Ups Load: connected to the LOAD port of the machine.

Parameter Meaning	Option	Description
Hybrid grid mode	On grid	Direct grid connection of excess PV energy
	Limit Power to ups	Ups load backflow prevention, photovoltaic or battery energy is only for the ups load, excess energy will not be connected to the grid
	Limit Power to home	Home load anti-backflow, solar or battery energy is only supplied to the home load, excess energy will not be connected to the grid.
PV energy manage	<ul style="list-style-type: none"> When mixed grid mode is set to "Limit Power to ups load" or when CT is not connected, the following load refers to the ups load. When mixed grid mode is set to "Limit Power to home load/On grid" and CT is connected, the following load refers to the ups load plus the home load. 	
	First to Load	PV power supply logic: load-charge-grid connection
	First to charging	PV power supply logic: charge-load-grid connection
	First to grid	PV power supply logic: load-grid connection-charge
Grid charging enable	Selectable grid participation in battery charging	
Battery energy manage	Standby	The battery does not discharge, and the battery is discharged only when the working state is off the grid.
	Battery to ups load	When the PV power is less than the UPS load power, the battery discharge is added.
	Battery to home load	The battery can supply the power to Home load
	Battery to grid sell	The battery can supply the power to grid.
Parallel mode	Stand-alone	Single inverter
	Parallel	The grid type setting is effective when set to split-phase.
	Three Phase A	The grid type setting is effective when set to three-phase.
	Three Phase B	
	Three Phase C	

Grid type	Single phase	When the grid type is single-phase,L1-L2 is Europe voltage,L1-L2 is 230V
	Three Phase	When the grid type is three-phase, the phase difference between L1 and L2 is 120° and the output voltage is 120V/208V
	Split Phase	When the grid type is split-phase, the phase difference between L1 and L2 is 180°, and the grid voltage is 120 V/240 V. Please select according to the actual grid type.
Output phase voltage	Settable: 100V,105V,110V,120V,127V	

5.2.2.2. Peak Shaving

Work mode setup [Return] [OK]

Work mode: Peak shaving

Timed charging enable

	Start Time	End Time	Stop SOC	Stop Volt	Max Power
①	00 : 00	00 : 00	100%	60.0V	60W
②	00 : 00	00 : 00	100%	60.0V	60W
③	00 : 00	00 : 00	100%	60.0V	60W

Timed discharging enable

	Start Time	End Time	Stop SOC	Stop Volt	Max Power
①	00 : 00	00 : 00	100%	60.0V	60W
②	00 : 00	00 : 00	100%	60.0V	60W
	00 : 00	00 : 00	100%	60.0V	60W

Parameter Meaning	Description
Time charging/ discharging enable	Select whether to turn on timed charging and discharging
Start/End Time	Setting the time period for timed charging and discharging
Stop SOC	Setting the battery charging cut-off SOC value and the cut-off SOC value for discharging during the timed charging and discharging time period (during BMS communication)
Stop Volt	Setting the battery charging cut-off voltage value and discharging cut-off voltage value during the timed charging and discharging time period (when the BMS is not communicating)
Max Power	Setting the battery charging power and discharging power during the timed charging and discharging time period

5.2.3 Battery setup

5.2.3.1. Battery Type

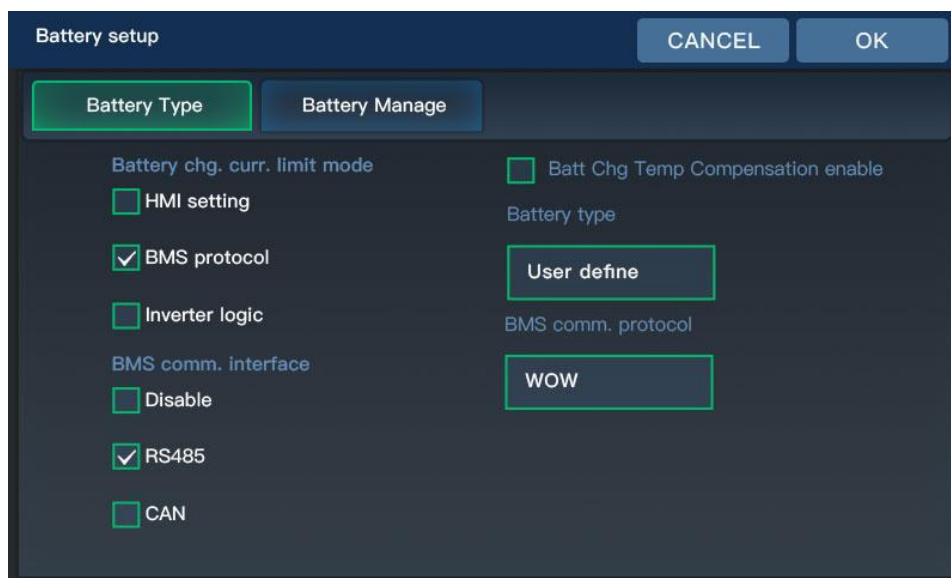

Parameter Meaning	Option	Description
Battery chg. curr. limit (Valid for BMS communication)	HMI	Maximum battery charging current is limited according to the inverter battery charging current setting value.
	BMS	Maximum battery charging current is limited by the current limit value of the BMS.
	Inverter	Maximum battery charging current is limited by the machine's derating logic.
BMS comm. interface	Disable	BMS does not communicate
	RS485	BMS RS485 communication function
	CAN	BMS CAN communication function
Battery Temperature Compensation	Select whether to turn on temperature compensation	
Battery Type	USER	User customizable to set all battery parameters
	SLd	Sealed Lead Acid Battery
	FLd	Open-ended lead-acid batteries
	GEL	gel lead-acid battery
	LFP/14/ 15/ LFP 16	Li-FePO4/14/15/16, corresponding to Li-FePO4 14 string, 15 string, 16 string
	N13/ N14	Ternary lithium batteries, N13/N14, corresponding to ternary lithium batteries 13 string, 14 string
	No battery	Without battery
BMS comm.protocol	<p>When the BMS port selection setting item = 485 or CAN, you need to select the corresponding lithium battery manufacturer brand for communication:</p> <p>1 : PACE-PACEEX 2 : RUDA-Ritar 3 : AOGUAN-=ALLGRAND BATTERY 4 : OULITE-OLITER 5 : CEF-CHANGFENG TECHNOLOGY 6 : XINWANGDA -SUNWODA 7 : DAQIN -DAKING 8 : WOW-SRNE 9: PYL-PYLONTECH 10 : MIT-FOXESS 11: XIX-XYE 12: POL-POWERMR 13: GUOX-Gotion 14: SMK-SMK 15: VOL-WEILAN 16:UZE-YUZE</p>	

5.2.3.2. Battery Manage

The image displays two screenshots of the 'Battery Manage' menu. The top screenshot shows the following settings:

Parameter	Value	Parameter	Value
Maximum chg. voltage	54.0V	Maximum chg. current	100.0A
Batt. Recharging voltage	50.4V	Max. chg. curr. by Grid	80.0A
Battery curr. stop chg.	3.0A	Bat. SOC stop chg.	100%

The bottom screenshot shows the following settings:

Parameter	Value	Parameter	Value
Batt volt. stop dchg	43.6V	Batt. soc. stop dchg	10%
Batt volt. restart dischg.	49.6V	Batt. SOC restart dischg.	100%
Battery under volt. alarm	46.4V	Batt under capacity alarm	15%
Batt volt low fault recovery	49.6V	Batt. SOC low fault	5%
Batt voltage low fault	43.6V	Batt volt. low fault delay	5S
Battery max. curr. dcharge	100.0A		

Parameter Meaning	Description
Maximum chg.voltage	When the battery is charging, the voltage reaches the value to stop charging
Batt. Recharging voltage	When the battery is fully charged, the inverter stops charging and resumes charging when the battery voltage falls below this voltage value.
Battery curr. stop chg.	when the charging current falls below this setting, the battery will stop charge.
Maximum chg. current	Setting the amount of current when charging the battery
Max. chg. curr. by Grid	When using mains charging, set the size of the battery mains charging current (the value is the battery current)
Bat.SOC stop chg.	"Charging will stop when the SOC value reaches this set point (effective when BMS communication is normal)."
Batt volt.stop dchg	When the battery reach this setting, it will stop discharging.
Batt volt.restart dischg	When the battery voltage is too low to discharge, the battery voltage needs to reach this setting to discharge again.
Battery under volt. alarm	Battery under-voltage alarm point, when the battery voltage is lower than the judgment point, the under-voltage alarm will be reported and the output will not be turned off.
Batt volt low fault recovery	When the battery report voltage low fault, the battery voltage reach this setting, the fault will be cleared.

Batt voltage low fault	When the battery voltage reach this setting, the inverter will report battery voltage low fault.
Battery max.curr.dcharge	Set the max battery discharge current,when the battery and grid hybrid load.
Batt.soc.stop.dchg	When the SOC value reaches this setting, the battery will stop discharge(valid when BMS communication is normal).
Batt.soc restart dischg	When the battery report SOC low fault, the battery SOC reach this setting, it can restart discharge(valid when BMS communication is normal).
Batt under capacity alarm	SOC value up to this setting will alarm. The inverter output will not shut down and the fault disappears if the SOC value exceeds 5% of the set value. (Valid when BMS communication is normal)
Batt.soc low fault	When the battery voltage reach this setting, the inverter will report battery SOC low fault and stop discharging(valid when BMS communication is normal).
Batt. Volt. low fault delay	When the battery voltage reaches the "Batt voltage low fault" setting, the battery will stop diacharging with a delay.

5.2.4 On grid setup

To enter this setting, you need to enter the password set by the user, the default password is "00000".

5.2.4.1.Basic

The screenshot shows the 'On grid setup' interface with the 'Basic' tab selected. The settings are as follows:

- Grid standard:** UL1741&IEEE1547.1-2020
- Grid frequency:** 50Hz (selected), 60Hz
- Sell Power Max:** 6000W
- External CT ratio:** 2000:1
- Buy Power Max:** 6000W
- zero-export power:** 20W
- On Grid Reactive Power:** 0%
- On Grid PF:** 0.300
- Reactive power over excited:**
- Reactive power under excited:**
- Power factor over excited:**
- Power factor under excited:**

Parameter Meaning	Description
Grid Standard	USA : UL1741&IEEE1547.1-2020
	California, USA:RULE21
	Hawaii, USA:HECO
	Other regions:GNL
Grid Frequency	Selection of local grid frequency, 50Hz/60Hz
CT ratio	When connecting an external CT, enter the ratio on the CT specification.

Sell power Max	On grid power
Buy power Max	Maximum power drawn from the grid. If the grid charging power + load power exceeds this setting, the machine reduces the charging power. (Setting range: 0 to rated power)
Zero-export power	Error calibration power in the case of backflow prevention, recommended setting 20-100W
On-Grid Reactive Power	Setting range 0-100%, % of reactive power
Reactive power over/under excited	Over indicates 0%-100% / Under indicates -100%-0%
On Grid PF	Setting range 0.8-1
Power factor over/under excited	Over indicates 0.8-1 / Under indicates -0.8 - -1

5.2.4.2. Enter Service(This setting is not recommended to be changed by the customer)

Parameter Meaning	Description
Enter Service enable	Grid-connect enable setting (on by default)
Connect Voltage Low	Grid-connected low voltage protection voltage
Connect Frequency Low	Grid-connected low-frequency protection points
Connect Voltage High	Grid-connected high-voltage protection voltage
Connect Frequency High	Grid-connected high-frequency protection points
Normal connect delay time	Grid normal connection, grid connection delay time
Normal connect Power Ramp Rate	Normal grid connection, rate of rise of grid-connected power
Reconnect delay time	Grid down reconnection, grid connection delay time
Reconnect Power Ramp Rate	Grid disconnection and reconnection, rate of rise of grid-connected power

5.2.4.3. Grid Protection (This setting is not recommended to be changed by the customer)

On grid setup Return OK

Basic **Enter Service** Grid Protection Other

Enter service enable

Connect Voltage Low	234.5V	Connect Frequency Low	50.00Hz
Connect Voltage High	234.5V	Connect Frequency High	50.00Hz
Normal connect delay time	50S	Normal Connect Power Ramp Rate	50S
Reconnect delay time	50S	Reconnect Power Ramp Rate	50S

Parameter Meaning	Description
LV1	Class 1 undervoltage protection point
LF1	Class 1 underfrequency protection point
LV2	Class 2 undervoltage protection point
LF2	Class 2 underfrequency protection point
HV1	Class 1 overvoltage protection point
HF1	Class 1 overfrequency protection point
HV2	Class 2 overvoltage protection point
HF2	Class 2 overfrequency protection point
Time	Protection Response Time

5.2.4.4. Other



Parameter Meaning	Description
Frequency Droop (F-P) enable	Adjustment of inverter output power according to grid frequency
Volt -Watt (V-P) curve enable	Adjustment of the inverter active power according to the set grid voltage
Volt-Var (V-Q) curve enable	Adjustment of the inverter reactive power according to the set grid voltage
Watt-Var (P-Q) curve enable	Adjustment of the inverter reactive power according to the set active power
Watt-PF (P-PF) curve enable	Adjustment of the power factor of the inverter according to the set active power
LVRT/HVRT enable	Adjustment of grid HV ride-through / LV ride-through values

5.2.5 Advance Setup

To enter this setting, you need to enter the password set by the user, the default password is "00000".

5.2.5.1. Generator

The screenshot shows the 'Advance setup' interface with the 'Generator' tab selected. The settings are as follows:

- Max charging current by gen.: 10.0A
- Generator rate power: 5000W
- Generator charging enable:
- Generator work mode:
 - Generator input:
 - Micro inverter input:

Parameter Meaning	Description
Max charging current by gen.	Maximum battery charging current during generator charging
Generator rate power	Setting the power of the generator up to the rated power of the inverter
Generator charging enable	Setting whether the generator is charged or not
Generator work mode	When connect the Generator, select" Generator input"
	When connect the Micro inverter, select" Micro inverter input"

5.2.5.2. Other

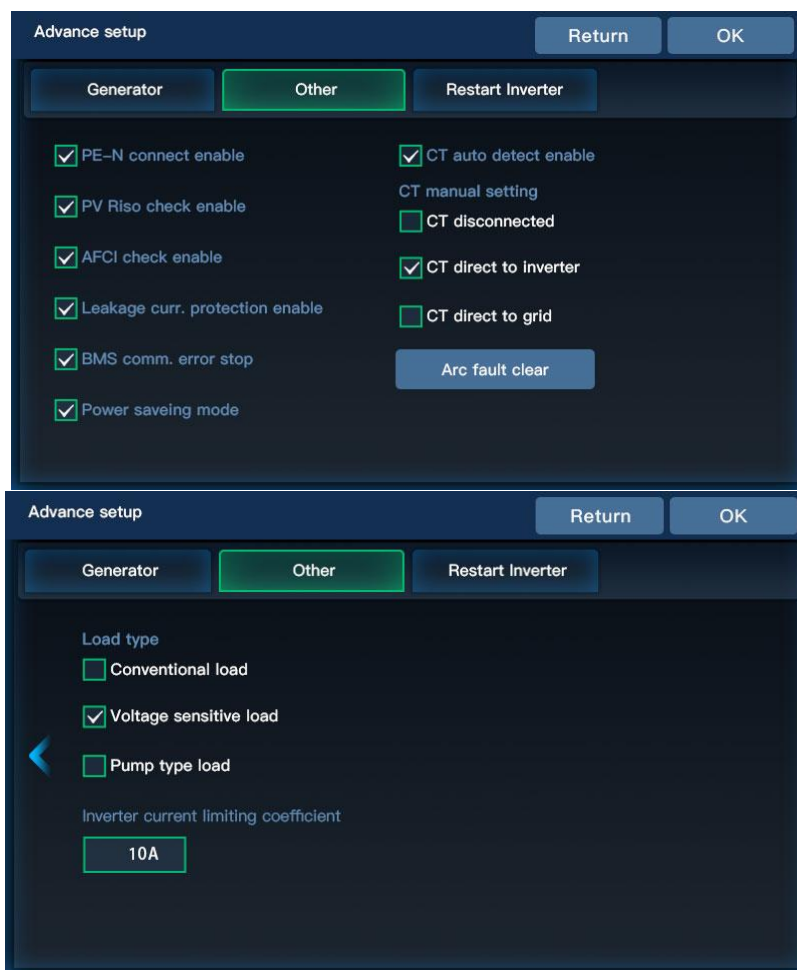

Parameter Meaning	Description
PE-N connect enable	Enable automatic switching of PE-N connections
PV Riso check enable	Enable PV insulation impedance detection
AFCI check enable	Turn on AFCI check
Leakage curr. protection enable	Enable leakage current protection
BMS comm. error stop	After turning on, the inverter output turns off when the machine reports 58 communication faults
Power saveing mode	After turning on the energy-saving mode, if the load is empty or less than 25W, the inverter output will be shut down after a delay of 5min; when the load is more than 40W, the inverter will start automatically.
CT auto detect enable	Automatically detect the CT, the result will report to "CT manual setting"
CT manual setting	According to the CT installation, select the CT direction
Arc fault clear	Clear the AFCI fault
Load type	According to the load that you have connected, select the load type
Inverter current limiting coefficient	When the inverter soft start, adjust the current coefficient(This setting doesn't recommend to be changed by the customer)

5.2.5.3. Restart

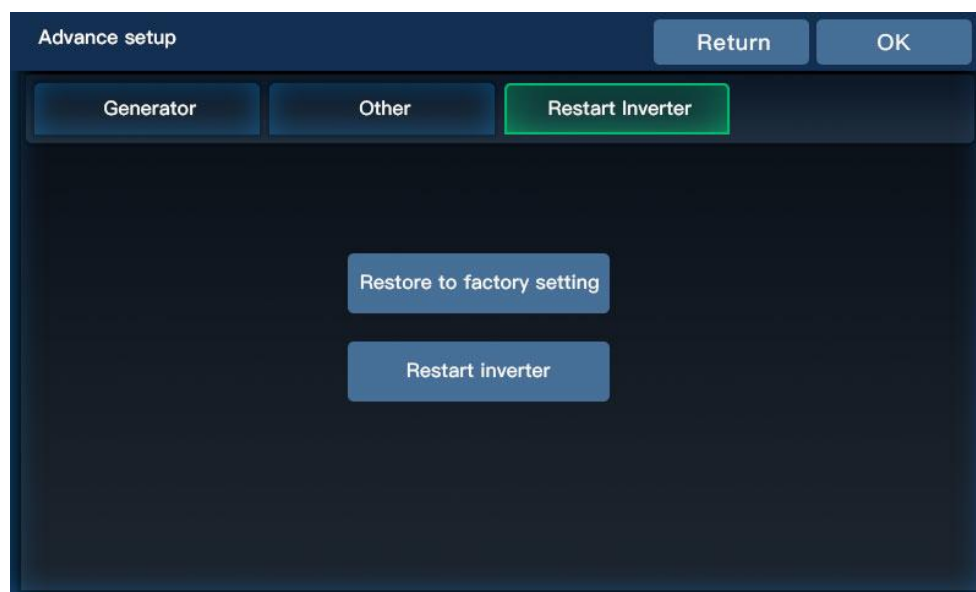

Parameter Meaning	Description
Restore Factory Settings	Reset all inverter settings to factory setting
Reboot Inverter	Restart the inverter

5.3、 Time-slot charging/discharging function

SEI series has the function of charging and discharging in different time periods, users can set different charging and discharging time periods according to the local peak and valley electricity price, so that the utility power and photovoltaic energy can be reasonably utilized.

When the utility price is expensive, the battery inverter can be used to supply power to the load; When the utility price is cheap, the utility can be used to supply and charge the load, which can maximize the user's savings in electricity costs.

Users can turn on/off the time-sharing charging/discharging function in the Setup menu parameters Segmented Charging Enable and Segmented Discharging Enable, and set the charging and discharging time periods in the parameters Timed Utility Charging Start/Time Settings and Timed Utility Discharging Start/Time Settings. Below is a case example to help users understand the function.

NOTICE

Before using this function for the first time, please set the local time and date, and then users can set the corresponding time slots according to the local peak and valley tariff charges.

Peak-Valley Electricity Tariff

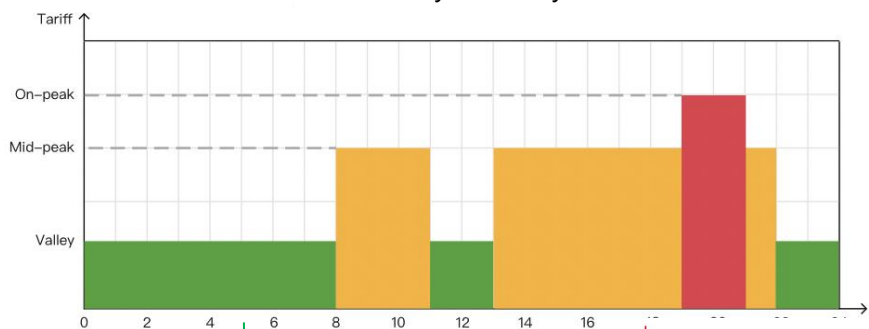

Time-slot Utility Charging/Carrying

Time-slot Battery Discharging Function

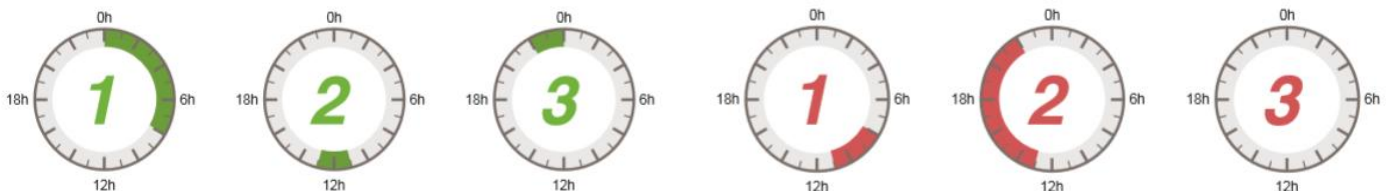

Three user-defined time slots are available, allowing users to freely set grid charging/loading periods from 00:00 to 23:59. During the user-set periods, solar energy will be prioritized if available. In the absence or insufficiency of solar energy output within the set periods, grid power will be used as a backup.

With 3 definable time periods, users can freely set the battery discharge time within the range of 00:00 to 23:59. During the time set by the user, the inverter will give priority to the battery inverter to carry the load, and if the battery power is insufficient, the inverter will automatically switch to mains power to ensure stable operation of the load.

5.4、 Battery parameter

- Lead-acid battery

Battery type Parameters	Sealed lead acid battery	Gel lead acid battery	Flooded lead acid battery	User-defined
	SLd	GEL	FLd	USE
Overdisconnect Voltage	60V	60V	60V	60V
Boost charging voltage	57.6V	56.8V	57.6V	40~60V (can be set)
Undervoltage alarm voltage	44V	44V	44V	40~60V (can be set)
Undervoltage disconnect voltage	42V	42V	42V	40~60V (can be set)
Discharge limiting voltage	40V	40V	40V	40~60V (can be set)
Overdischarge delay time	5s	5s	5s	1~30s (can be set)
Enhanced Charge Cycle	120min	120min	120min	10~900min (can be set)

- Li-ion batter

Battery type Parameters	Ternary		LFP			User-defined
	N13	N14	L16	L15	L14	USE
Overdisconnect Voltage	60V	60V	60V	60V	60V	60V
Boost charging voltage	53.2V	57.6V	56.8V	53.2V	49.2V	40~60V (can be set)
Undervoltage alarm voltage	43.6V	46.8V	49.6V	46.4V	43.2V	40~60V (can be set)
Undervoltage disconnect voltage	38.8V	42V	48.8V	45.6V	42V	40~60V (can be set)
Discharge limiting voltage	36.4V	39.2V	46.4V	43.6V	40.8V	40~60V (can be set)
Overdischarge delay time	30s	30s	30s	30s	30s	1~30s (can be set)
Enhanced Charge Cycle	120min (can be set)	120min (can be set)	120min (can be set)	120min (can be set)	120min (can be set)	10~900min (can be set)

6. Communication

6.1、Overview

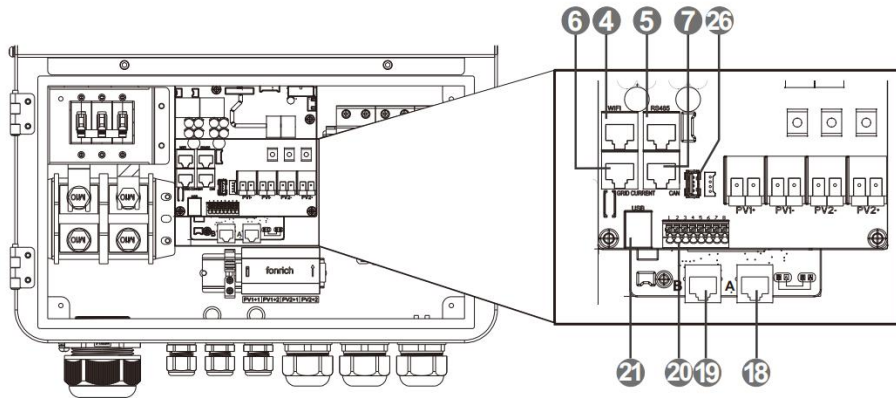

4	WIFI port	19	Parallel port B
5	RS485 port	20	Dry contact
6	External CT port	21	USB-B port
7	CAN port	26	USB-A port
18	Parallel port A		

6.2、USB-B port

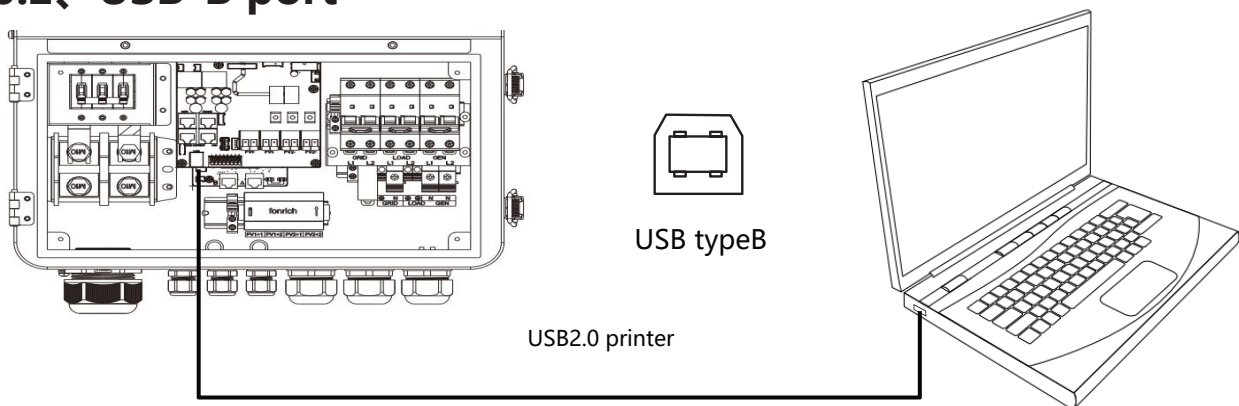

The user can read and modify device parameters through this port by using the host software. Please contact us for the host software installation package if you require one.

6.3、WIFI port

The WIFI port is used to connect to the Wi-Fi/GPRS data acquisition module, which allows users to view the operating status and parameters of the inverter through the cell phone APP.

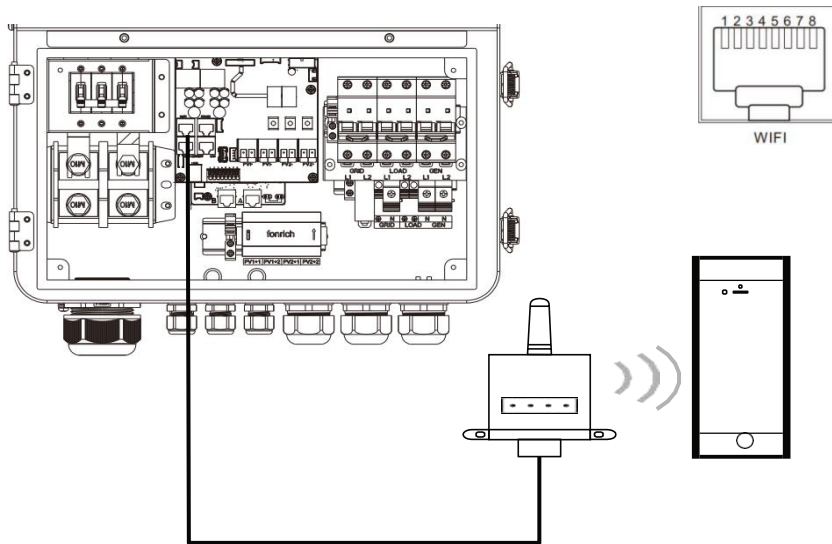

RJ45	Definition
Pin 1	5V
Pin 2	GND
Pin 3	/
Pin 4	/
Pin 5	/
Pin 6	/
Pin 7	RS485-A
Pin 8	RS485-B

6.4、RS485 port

The RS485 port is used to connect to the BMS of Liion battery.

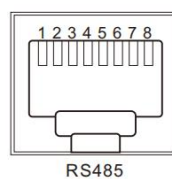

RJ45	定义
Pin 1	/
Pin 2	/
Pin 3	/
Pin 4	CANH
Pin 5	CANL
Pin 6	/
Pin 7	RS485-A
Pin 8	RS485-B

6.5、CAN port

The CAN port is used to connect to the BMS of Liion battery .

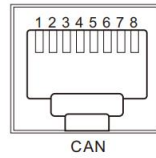

RJ45	Definition
Pin 1	/
Pin 2	/
Pin 3	/
Pin 4	CANH
Pin 5	CANL
Pin 6	/
Pin 7	/
Pin 8	/



NOTICE

If you need the inverter to communicate with the lithium battery BMS, please contact us for the communication protocol or to upgrade the inverter to the corresponding software program.

6.5、 External CT port

1. Length of CT Output Line Wrap: 4m
2. Normally The CT direction is "to inverter"

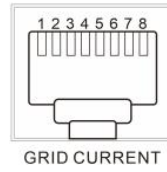

RJ45	Definition
Pin 1	CT3+
Pin 2	CT3-
Pin 3	/
Pin 4	CT2+
Pin 5	CT2-
Pin 6	/
Pin 7	CT1+
Pin 8	CT1-

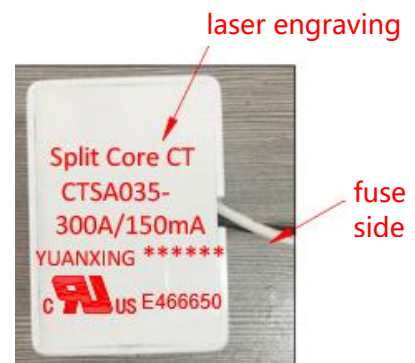
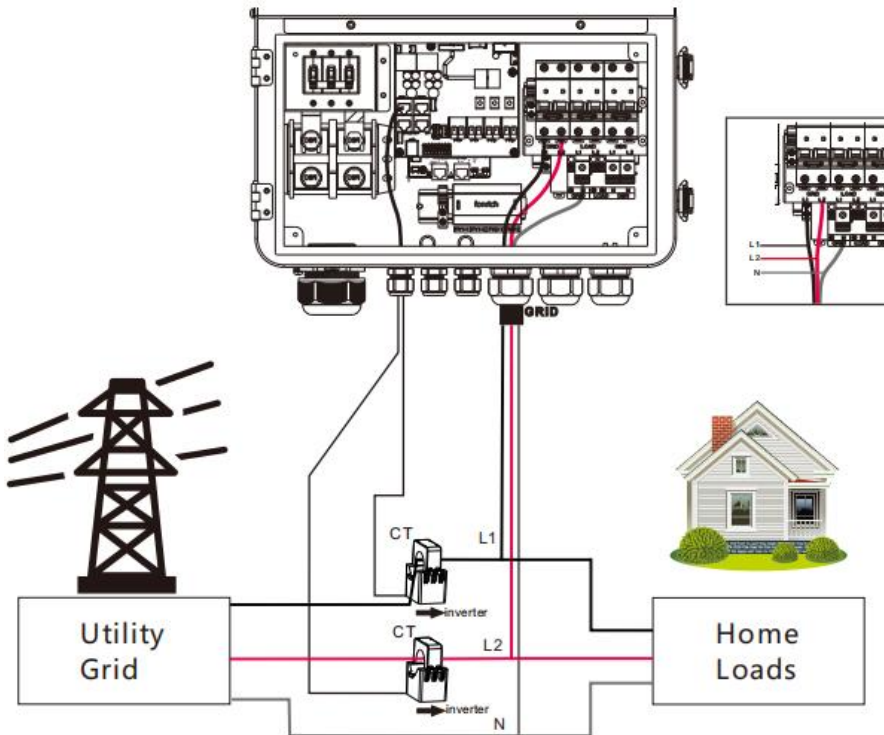

3. Current transformer (CT) dimensions:(mm)

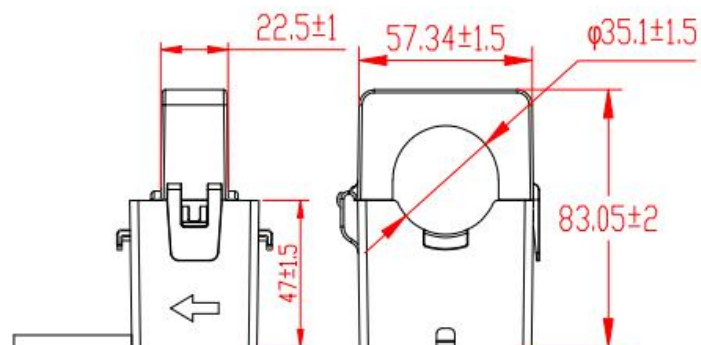

6.6、 Dry contact

Dry contact port with 3 functions:

1. RSD power supply
2. Temperature sampling (reserved)
3. Generator remote start/stop

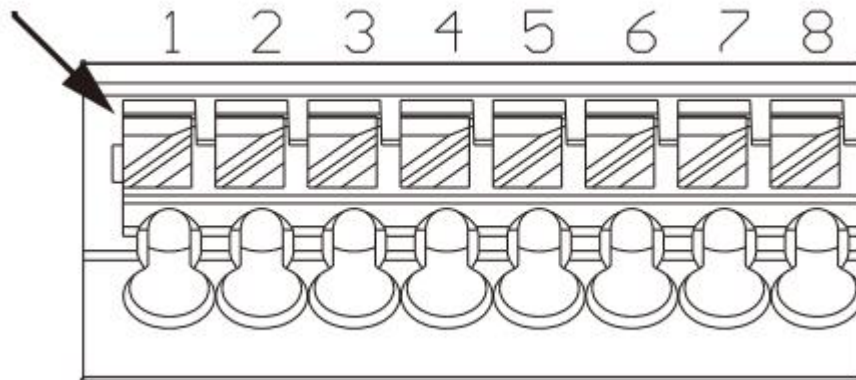

Function	Description
RSD power supply	PIN 1 is GND, PIN 2 is RSD 12V+
Temperature sampling (reserved)	Pin 1 & Pin 5 can be used for battery temperature sampling compensation.
Generator remote start/stop	<p>When the generator is connected, the following conditions need to be met.</p> <ol style="list-style-type: none"> 1、 Remote start the generator when there is no grid connection. 2、 When there is no BMS connection, the generator will be remotely started when the battery voltage is below the undervoltage alarm threshold or when the battery switches to the grid voltage. 3、 When connected to the BMS, the generator will be remotely started when the battery SOC is lower than the set point for switching to grid SOC. 4、 When there is no BMS connection, the generator will be remotely stopped when the battery voltage reaches the voltage threshold for switching from grid to battery, or when the battery is fully charged. 5、 When the BMS is connected, the generator will be remotely shut down when the battery SOC is lower than the set value for switching from grid to battery SOC. 6. Remote shutdown of the generator when the battery is fully charged. <p>Remote start of the generator: Pin 6 to Pin 7 is normally open, Pin 7 to Pin 8 is normally closed.</p> <p>Remote generator shutdown: Pin 6 to 7 is normally closed, Pin 7 to 8 is normally open.</p> <p>(Pin 6/7/8 outputs 125Vac/1A, 230Vac/1A, 30Vdc/1A)</p>

① NOTICE

If you need to use the remote start/stop function of the generator with dry contact, ensure that the generator has ATS and supports remote start/stop.

7. Fault and Remedy

7.1 Fault code

Fault code	Fault name	Whether it affects the output or not	Description
01	BatVoltLow	Yes	Battery undervoltage alarm.
02	BatOverCurrSw	Yes	Battery discharge average current overcurrent (software protection).
03	BatOpen	Yes	Battery not-connected alarm
04	BatLowEod	Yes	Battery undervoltage stop discharge alarm.
05	BatOverCurrHw	Yes	Battery overcurrent (hardware protection)
06	BatOverVolt	Yes	Charging overvoltage protection
07	BusOverVoltHw	Yes	Bus overvoltage (hardware protection)
08	BusOverVoltSw	Yes	Bus overvoltage (software protection)
09	PvVoltHigh	Yes	PV overvoltage protection.
10	PvBoostOCSw	No	Boost overcurrent (software protection)
11	PvBoostOCHw	No	Boost overcurrent (hardware protection)
12	HESCommErr	Yes	Master-slave HES communication failure
13	OverloadBypass	Yes	Bypass overload protection
14	OverloadInverter	Yes	Inverter overload protection.
15	AcOverCurrHw	Yes	Inverter overcurrent hardware protection
16	AuxDspReqOffPWM	Yes	Requesting a shutdown fault from the chip
17	InvShort	Yes	Inverter short-circuit protection.
18	Bussoftfailed	Yes	Bus soft start failure
19	OverTemperMppt	No	Buck heat sink over temperature protection
20	OverTemperInv	Yes	Inverter AC output with load or AC charging radiator over-temperature protection.
21	FanFail	Yes	Fan blockage or failure fault
22	EEPROM	Yes	Memory failure
23	ModelNumErr	Yes	Model setting error
24	Busdiff	Yes	Positive and negative bus voltage imbalance

25	BusShort	Yes	Busbar short circuit
26	Rlyshort	Yes	Inverter AC output backfeed to bypass AC output
28	LinePhaseErr	Yes	Utility input phase error
29	BusVoltLow	Yes	Low bus voltage protection
30	BatCapacityLow1	Yes	Alarm given when battery capacity rate is lower than 10% (setting BMS to enable validity).
31	BatCapacityLow2	No	Alarm given when battery capacity rate is lower than 5% (setting BMS to enable validity).
32	BatCapacityLowStop	Yes	Inverter stops when battery capacity is low (setting BMS to enable validity).
34	CanCommFault	Yes	CAN communication fault in parallel operation.
35	ParaAddrErr	Yes	Parallel ID (communication address) setting error.
37	ParaShareCurrErr	Yes	Parallel current sharing fault
38	ParaBattVoltDiff	Yes	Large battery voltage difference in parallel mode.
39	ParaAcSrcDiff	Yes	Inconsistent AC input source in parallel mode.
40	ParaHwSynErr	Yes	Hardware synchronization signal error in parallel mode.
41	InvDcVoltErr	Yes	Inverter DC voltage error.
42	SysFwVersionDiff	Yes	Inconsistent system firmware version in parallel mode.
43	ParaLineContErr	Yes	Parallel line connection error in parallel mode.
44	Serial number error	Yes	No serial number set at factory
45	Error setting of split-phase mode	Yes	Item "Parallel" setting error
49	Grid over voltage	Yes	Selects the local corresponding grid standard.
50	Grid under voltage	Yes	
51	Grid over Frequency	Yes	
52	Grid under Frequency	Yes	
53	Grid loss	Yes	
54	Grid DC current over	Yes	
55	Grid standard un init	Yes	

56	Low insulation resistance fault	No	PV1+, PV2+ and PV- abnormally low impedance to ground.
57	Leakage current overload fault	Yes	System leakage current exceeds limit.
58	BMSComErr	No	BMS communication failure
60	BMSUnderTem	No	BMS alarm battery low temperature.
61	BMSOverTem	Yes	BMS alarm battery over temperature. (Effective after successful BMS communication)
62	BMSOverCur	Yes	BMS alarm battery over current. (Effective after successful BMS communication)
63	BMSUnderVolt	No	BMS alarm low battery. (Effective after successful BMS communication)

7.2、Troubleshooting

Fault code	Faults	Remedy
Display	No display on the screen	Check if the battery switch or PV switch is closed; whether the switch is in the "ON" state; press any button on the screen to exit the screen sleep mode
【06】	Battery overvoltage protection	Check that the battery voltage does not exceed the protection value. If it does, discharge the battery until the voltage falls below the battery over-voltage recovery point.
【01】 【04】	Battery undervoltage protection	Charge the battery until it returns to the low voltage disconnection recovery voltage.
【21】	Fan failure	Check if the fan is not turning or blocked by foreign object.
【19】 【20】	Heat sink over temperature protection	When the temperature of the device is cooled below the recovery temperature, normal charge and discharge control is resumed.
【13】 【14】	Bypass overload protection, inverter overload protection	① Reduce the use of power equipment; ② Restart the unit to resume load output.
【17】	Inverter short-circuit protection	① Check the load connection carefully and clear the short-circuit fault points; ② Re-power up to resume load output.
【09】	PV overvoltage	Use a multimeter to check if the PV input voltage exceeds the maximum allowable input voltage rated.
【03】	Battery disconnected alarm	Check if the battery is not connected or if the battery circuit breaker is not closed.
【40】 【43】	Parallel connection fault	Check if the parallel line is not connected well, such as loose or wrong connection.
【35】	Parallel ID setting error	Check whether the setting of parallel ID number is repeated.
【37】	Parallel current sharing fault	Check if the parallel current sharing line is not connected well, such as loose or wrong connection.
【39】	Inconsistent AC input source in parallel mode	Check whether the parallel AC inputs are from the same input interface
【42】	Inconsistent system firmware version in parallel mode	Check whether the software version of each inverter is consistent.
【44】	Serial number error	Incorrect device serial number setting.

【45】	Parallel mode error	There is a device in the parallel system with the wrong parallel mode setting.
【49】	High grid voltage	Check that the grid voltage is within the normal range, if the grid voltage is abnormal, wait until the grid voltage is restored.
【50】	Low grid voltage	Check that the grid voltage is within the normal range, if the grid voltage is abnormal, wait until the grid voltage is restored.
【51】	High grid frequency	Check that the grid frequency is within the normal range, if the grid frequency is abnormal, wait until the grid frequency is restored.
【52】	Low grid frequency	Check that the grid frequency is within the normal range, if the grid frequency is abnormal, wait until the grid frequency is restored.
【53】	Grid unconnected	Check if the grid is correctly connected, e.g. if the switch is closed and if the grid is disconnected.
【54】	Grid-connected current with DC component over	Power down and restart the device, if it continues to report faults, contact the manufacturer after sales.
【55】	Grid standard not set	Setting standards for grid integration
【56】	Low insulation resistance fault	Check that the system is well grounded and that the PV modules and cables are not worn
【57】	Leakage current overload fault	Check that the system is well grounded and that the loads are not operating abnormally.

**NOTICE**

If you encounter a fault with the product that cannot be solved by the methods in the table above, please contact our after-sales service for technical support and do not disassemble the equipment yourself.

8. Protection and Maintenance

8.1 Protection features

No	Protection Feature	Instruction
1	PV current limiting protection	When the charging current or power of the PV array configured exceeds the PV input rated value, the inverter will limit the input power and charge at the rated.
2	PV input over-voltage	If the PV voltage exceeds the maximum value allowed by the hardware, the machine will report a fault and stop the PV boost to output a sinusoidal AC wave.
3	PV night reverse current protection	At night, the battery is prevented from discharging through the PV module because the battery voltage is greater than the voltage of PV module.
4	Utility input overvoltage protection	When the mains voltage exceeds 140Vac, the mains charging will be stopped and the output will be inverted.
5	AC input under-voltage protection	When the mains voltage falls below 90Vac, the mains charging will be stopped and the output will be inverted.
6	Battery over-voltage protection	When the battery voltage reaches the over-voltage cut-off point, the PV and the utility will automatically stop charging to prevent the battery from being overcharged and damaged.
7	Battery under-voltage protection	When the battery voltage reaches the under-voltage cut-off point, the inverter will automatically stop the battery discharge to prevent damage from over-discharging the battery
8	Battery over-current protection	After a period when the battery current exceeds that allowed by the hardware, the machine will switch off the output and stop discharging the battery.
9	AC output short-circuit protection	When a short-circuit fault occurs at the load output for more than 200ms, the output AC voltage will be turned off immediately, and then manually re-powered and turned on before normal output can be restored. (Non-utility bypass condition)
10	Heat sink over-temperature protection	When the internal temperature of the inverter is too high, the inverter will stop charging and discharging; when the temperature returns to normal, the inverter will resume charging and discharging.
11	Inverter over-load protection	After triggering the overload protection the inverter will resume output after 3 minutes, 5 consecutive overloads will switch off the output until the inverter is restarted.

12	AC output reverse	Prevents AC back flow from the battery inverter to the bypass AC input.
13	Bypass over-current protection	Built-in AC input over-current protection circuit breaker
14	Bypass phase inconsistency protection	When the phase of the bypass input and the phase of the inverter split do not match, the inverter disables switching to the bypass output to prevent the load from dropping out or short-circuiting when switching to the bypass.

8.2 Maintenance

To maintain optimum and long-lasting working performance, we recommend that the following items are checked twice a year.

1. Ensure that the airflow around the inverter is not blocked and remove any dirt or debris from the radiator.
2. Check that all exposed conductors are not damaged by sunlight, friction with other surrounding objects, dry rot, insect or rodent damage, etc. The conductors need to be repaired or replaced if necessary.
3. Verify that the indications and displays are consistent with the operation of the equipment, note any faults or incorrect displays and take corrective action if necessary.
4. Check all terminals for signs of corrosion, insulation damage, high temperatures or burning/discolouration and tighten terminal screws.
5. Check for dirt, nesting insects and corrosion, clean as required, Clean the insect screen regularly.
6. If the lightning arrester has failed, replace the failed arrester in time to prevent lightning damage to the inverter or other equipment of the user.

 **DANGER**

- Make sure that the inverter is disconnected from all power sources and that the capacitors are fully discharged before carrying out any checks or operations to avoid the risk of electric shock.

The Company shall not be liable for damage caused by :

1. Damage caused by improper use or use in a wrong location.
2. Photovoltaic modules with an open circuit voltage exceeding the maximum permissible voltage.
3. Damage caused by the operating temperature exceeding the restricted operating temperature range
4. Dismantling and repair of the inverter by unauthorised persons.
5. Damage caused by force majeure: damage during transport or handling of the inverter.

9. Datasheet

MODEL	SEI-8K-UP	SEI-10K-UP	SEI-12K-UP	Settable
Inverter output				
Rated Output Power	8800W	10,000W	@240V 12000W @208V 10400W	
Max. Peak Power	2 times rated power			
Rated Output Voltage	120/240Vac (Split-phase) 120/208V(Three-phase)			√
Output voltage error	@240V 36.6A @208V 42.3A	@240V 41.7A @208V 48.1A	50A	
Load Capacity of Motors	5HP	6HP	6HP	
Rated AC Frequency	50/60Hz			√
Waveform	Pure Sine Wave			
Parallel capacity	6			
Battery				
Battery Type	Li-ion / Lead-Acid / User Defined			√
Rated Battery Voltage	48Vdc			
Voltage Range	40-60Vdc			√
Max. PV Charging Current	200A			√
Max. Grid Charging Current	120A			√
Max. Generator Charging Current	60A			√
Max. Hybrid Charging Current	200A			√
PV input				
Num. of MPP Trackers	2			
Max. PV array power	5500W/5500W	5500W/5500W	6600W/6600W	
Max. input current	25A+25A			
Max. Voltage of Open Circuit	550Vdc+550Vdc			
MPPT Voltage Range	125-450Vdc/125-450Vdc			
Grid / Generator input				
Input Voltage Range	90-140Vac			
Frequency Range	50/60Hz			
Bypass phase current	63A			
Efficiency				
MPPT Tracking Efficiency	99.9%			
Max Efficiency	97.5%			
CEC Efficiency	96.5%			
Basic data				

Dimensions	750*440*240mm	
Weight	42kg	
Protection Degree	IP65	
Operating Temperature Range	-25~60°C, >45°C derated	
Noise	<60dB	
Cooling Method	Heat sink + intelligent fan cooling	
Communication		
Communication port	RS485 / CAN / USB / Dry contact	√
External Modules (Optional)	Wi-Fi / GPRS	√
Certified specifications		
Safety standards	UL1741&IEEE1547.1-2020,CEC, RULE 21, HECO	
EMC	FCC 15 class B	
RoHS	Yes	